

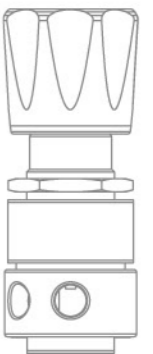

## *Complete System Solutions*

Whether your needs are components like regulators and valves or pressure systems and assemblies, NAI-LOK provides expert application and customer support from simple industrial applications to high tech complex projects.



# TABLE OF CONTENTS



## REGULATORS

- Cylinder Pressure Regulator ..... 04
- High Flow Regulator 1/2" ..... 05
- High Flow Regulator 3/4" ..... 06
- Dual Stage Regulator ..... 07
- High Pressure Regulator ..... 08
- High Flow Regulator 1" ..... 09
- Back Pressure Regulator ..... 10
- High Flow Regulator 1-1/2" ..... 11
- High Flow Regulator 2" ..... 12
- PRM Panel Regulator ..... 13
- Semi-automatic Changeover System ..... 14
- PRD Panel Regulator ..... 16

## ACCESSORIES

- Instrumentation Valves ..... 19
- Cylinder Connectors ..... 30
- Seamless Tubing ..... 31
- Metal Hoses ..... 32
- Tube Fittings ..... 35

## NR11 SERIES Cylinder Pressure Regulator



### Features

- Good protection against burst and corrosion due to diaphragm material hastelloy.
- Available in chrome plated brass, alloy.
- Stable outlet pressure
- 6 ports flexible configuration
- Panel mounting nut option
- Purity max. 6.0

### Technical Data

Ports	1/4" NPT
Design Proof Pressure	150% maximum rated pressure
Body Material	316 Stainless steel / Chrome plated brass
Bonnet Material	Stainless steel /Brass
Diaphragm	Hastelloy ® / 316 Stainless steel (standard)
Seat	Teflon®
Maximum Inlet Pressure	3500 psig (241 bar) / 400 psig (27.6 bar)
Outlet Pressure Ranges	0- 25 psig (0-1.7 bar) / 0-50 psig (0-3.4) / 0-250 psig (0-17.2 bar) / 0-450psig (0-31 bar)
Operating Temperature	-40°F to 165°F (-40°C to 74°C)
Leakage	Internal: Bubble-tight External: Design to meet $\leq 2 \times 10^{-8}$ atm cc / sec He
Flow Capacity	Cv=0.06
Standard Optional	CGA, relief valve, pressure gauges, etc.

### Flow Data

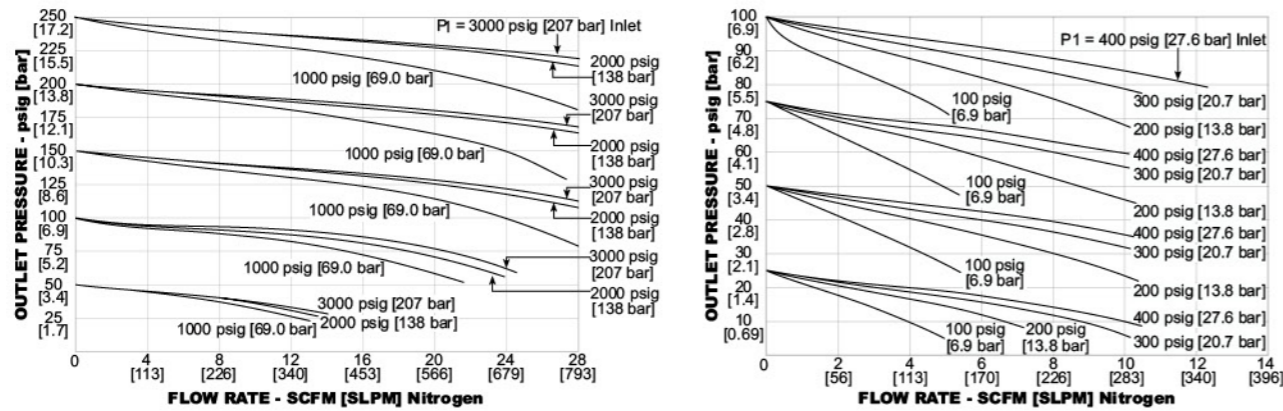

### Dimension (mm)

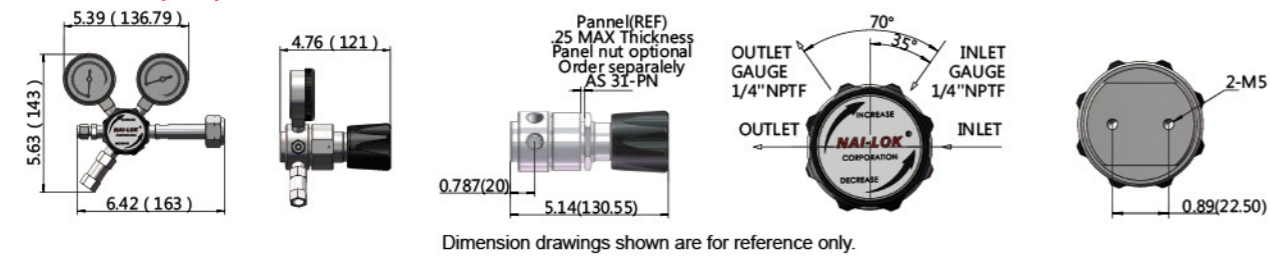

Dimension drawings shown are for reference only.

### Ordering Information

NR11	S	0	F	4	1	4	W	R
BASIC SERIES	BODY MATERIAL	OUTLET PRESSURE RANGES	INLET AND OUTLET PORT TYPE	INLET AND OUTLET PORT SIZE	INLET PRESSURE	PORT TYPE	GAUGE	OPTION
NR11	C - Chrome plated brass S - 316 Stainless steel	0 - 0-25psig 0-1.7bar 1 - 0-50psig 0-3.4bar 2 - 0-100psig 0-6.9bar 3 - 0-250psig 0-17.2bar 4 - 0-450psig 0-31bar (with 3500psig / 241bar inlet only)	F - NPTF	4 - 1/4"	1 - 3500psig 241bar 2 - 400psig 27.6bar	3 - 3 Ports 4 - 4 Ports 6 - 6 Ports	0-Without W-With	R-Relief valve

## NR12 SERIES High Flow Regulator



### Features

- Good protection against burst and corrosion due to diaphragm material hastelloy.
- 316 Stainless steel body for corrosive gases
- Gauge ports are standard
- Stable outlet pressure
- High flow rates

### Technical Data

Ports	1/2" NPT
Design Proof Pressure	150% maximum rated pressure
Body Material	316 Stainless steel
Bonnet Material	316 Stainless steel
Diaphragm	Hastelloy ® / 316 Stainless steel (standard)
Seat	Teflon®
Maximum Inlet Pressure	3000 psig (207 bar) / 500 psig (34.5 bar)
Outlet Pressure Ranges	0-25 psig (0-1.7 bar) / 0- 50 psig (0-3.4 bar) / 0-100 psig (0-6.9 bar) / 0-200 psig (0-13.8 bar)
Operating Temperature	-40°F to 140°F (-40°C to 60°C)
Leakage	Internal: Bubble-tight External: Design to meet $< 2 \times 10^{-8}$ atm cc / sec He
Flow Capacity	Cv=1.0
Standard Optional	Inlet and outlet gauges

### Flow Data

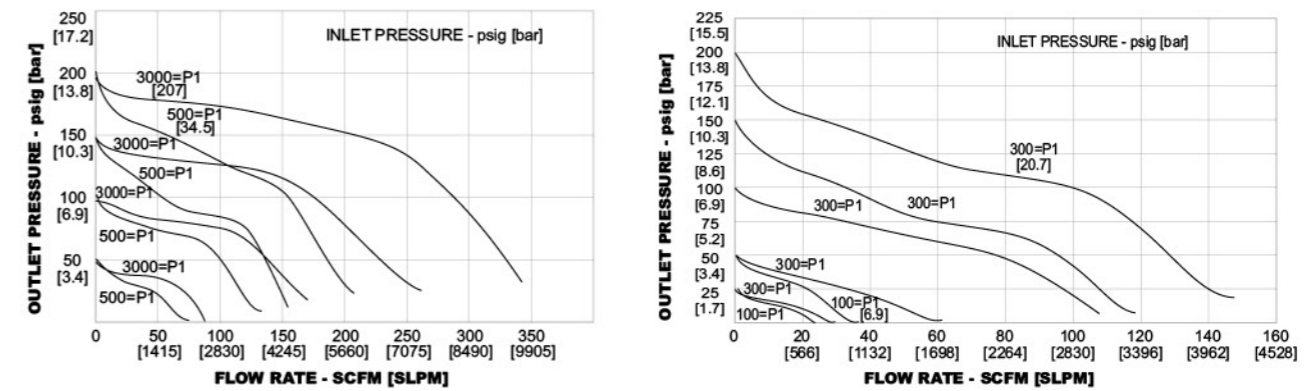

### Dimension (mm)

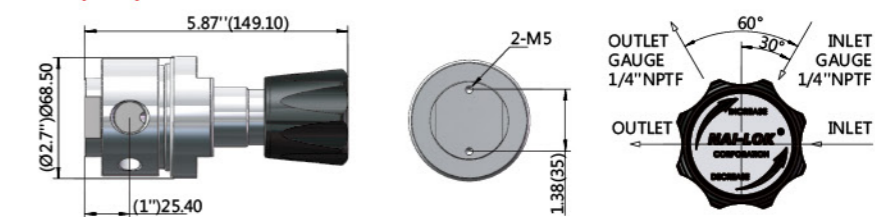

Dimension drawings shown are for reference only.

### Ordering Information

NR12	S	0	F	8	1	4	W
BASIC SERIES	BODY MATERIAL	OUTLET PRESSURE RANGES	INLET AND OUTLET PORT TYPE	INLET AND OUTLET PORT SIZE	INLET PRESSURE	PORT TYPE	GAUGE
NR12	S - 316 Stainless steel	0 - 0-25psig 0-1.7bar 1 - 0-50psig 0-3.4bar 2 - 0-100psig 0-6.9bar 3 - 0-150psig 0-10.3bar 4 - 0-200psig 0-13.8bar	F - NPTF	8 - 1/2"	1 - 3000psig 207bar 2 - 500psig 34.5bar	3 - 3 Ports 4 - 4 Ports	0-Without W-With

## NR13 SERIES High Flow Regulator



### Features

- Accurate and designed to provide high flow at low control pressure
- Good protection against burst and corrosion due to diaphragm material hastelloy.
- 316 Stainless steel body for corrosive gases
- Gauge ports are standard
- Stable outlet pressure

### Technical Data

Ports	3/4" NPT
Design Proof Pressure	150% maximum rated pressure
Body Material	316 Stainless steel
Bonnet Material	316 Stainless steel
Diaphragm	Hastelloy ® / 316 Stainless steel (standard)
Seat	Teflon ®
Maximum Inlet Pressure	3000 psig (207 bar) / 500 psig (34.5 bar)
Outlet Pressure Ranges	0- 25 psig (1.7 bar) / 0-50 psig (3.4 bar) / 0-150 psig (17.2 bar) / 0-200 psig (0-13.8 bar)
Operating Temperature	-40°F to 165°F (-40°C to 74°C)
Leakage	Internal: Bubble-tight External: Design to meet $< 2 \times 10^{-8}$ atm cc / sec He
Flow Capacity	Cv=1.8
Standard Optional	Inlet and outlet gauges

### Flow Data

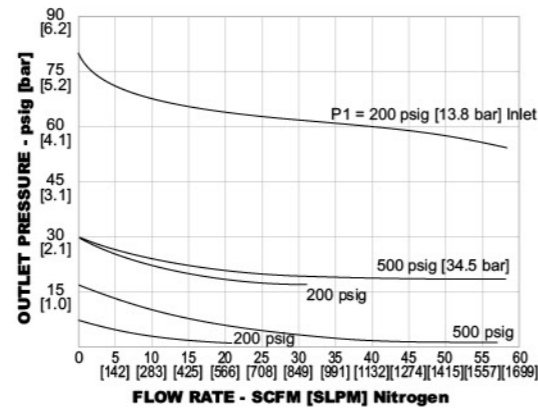

### Dimension (mm)

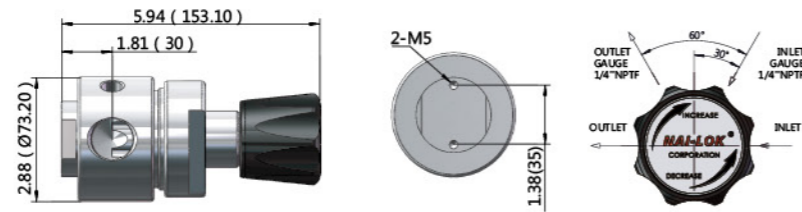

Dimension drawings shown are for reference only.

### Ordering Information

NR13	S	0	F	12	1	4	W
BASIC SERIES	BODY MATERIAL	OUTLET PRESSURE RANGES	INLET AND OUTLET PORT TYPE	INLET AND OUTLET PORT SIZE	INLET PRESSURE	PORT TYPE	GAUGE
NR13	S - 316 Stainless Steel	0 - 0.25psig 0-1.7bar 1 - 0.50psig 0-3.4bar 2 - 0.100psig 0-6.9bar 3 - 0.150psig 0-10.3bar 4 - 0.200psig 0-13.8bar	F - NPTF	12 - 3/4"	1 - 3000psig 207bar 2 - 500psig 34.5bar	3 - 3 Ports 4 - 4 Ports	0-Without W-With

## NR31 SERIES Dual-Stage Regulator



### Features

- Specially designed to regulate high pressure gas to low pressure status.
- Provide a continuous, accurate outlet pressure regardless of inlet pressure fluctuations
- Features a unique metal-to-metal diaphragm to body seal
- Diaphragms are convoluted for greater accuracy and sensitivity
- Available in chrome plated brass

### Technical Data

Ports	1/4" NPT
Design Proof Pressure	150% maximum rated pressure
Body Material	316 Stainless steel / Chrome plated brass
Bonnet Material	Stainless steel / Brass
Diaphragm	Hastelloy ® / 316 Stainless steel (standard)
Seat	Teflon ®
Maximum Inlet Pressure	3500 psig (241 bar)
Outlet Pressure Ranges	0-25 psig (0-1.7 bar) / 0-50 psig (0-3.4 bar) / 0-100 psig (0- 6.9 bar) / 0-250 psig (0-17.2 bar)
Operating Temperature	-40°F to 165°F (-40°C to 74°C)
Leakage	Internal: Bubble-tight External: Design to meet $\leq 2 \times 10^{-8}$ atm cc / sec He
Flow Capacity	Cv=0.05
Standard Optional	CGA, Inlet and outlet gauges, relief valve

### Flow Data

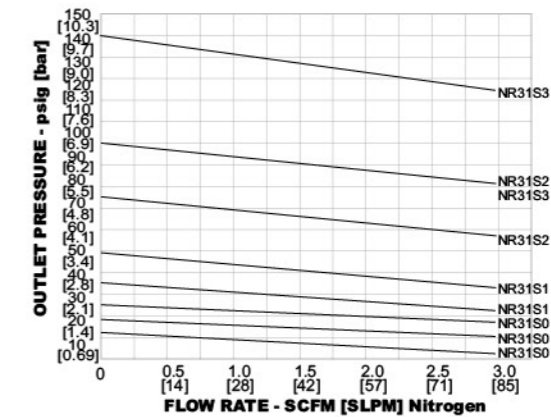

### Dimension (mm)

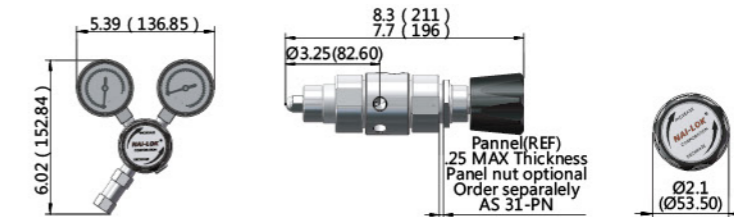

Dimension drawings shown are for reference only.

### Ordering Information

NR31	S	0	F	4	1	4	W	R
BASIC SERIES	BODY MATERIAL	OUTLET PRESSURE RANGES	INLET AND OUTLET PORT TYPE	INLET AND OUTLET PORT SIZE	INLET PRESSURE	PORT TYPE	GAUGE	OPTION
NR31	C - Chrome plated brass S - 316 Stainless steel	0 - 0.25psig 0-1.7bar 1 - 0.50psig 0-3.4bar 2 - 0.100psig 0-6.9bar 3 - 0.150psig 0-10.3bar 4 - 0.250psig 0-17.2bar	F - NPTF	4 - 1/4"	1 - 3500psig 241bar	4 - 4 Ports 5 - 5 Ports	0-Without W-With	R-Relief valve

**NR41 SERIES**  
**High Pressure Regulator**



**Features**

- Compact design
- Available in chrome plated brass
- Numerous inlet and outlet porting options
- Excellent sensitivity through a wide range of pressure settings
- Piston-sensed design ensures safety and reliability

**Technical Data**

Ports	1/4" NPT
Design Proof Pressure	150% maximum rated pressure
Body Material	316 Stainless steel / Chrome plated brass
Bonnet Material	Stainless steel /Brass
Main Valve	316 Stainless steel
Seat	Teflon ®
Maximum Inlet Pressure	6000 psig (414 bar)
Outlet Pressure Ranges	0-1000 psig (0-69 bar) / 0-1500 psig (0-103 bar) / 0-3000 psig (207 bar)
Operating Temperature	-15°F to 165°F (-26°C to 74°C)
Leakage	Bubble-tight
Flow Capacity	Cv=0.06 (non-venting)

**Flow Data**

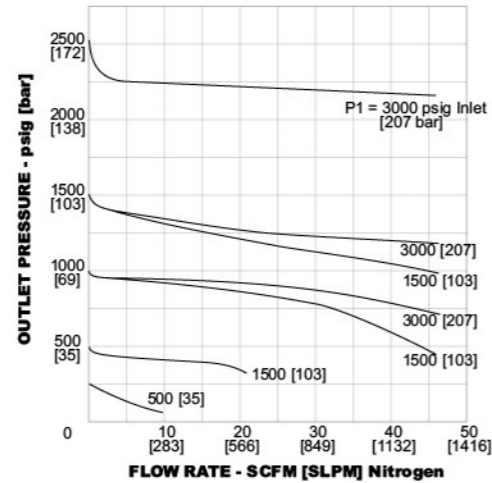

**Dimension (mm)**

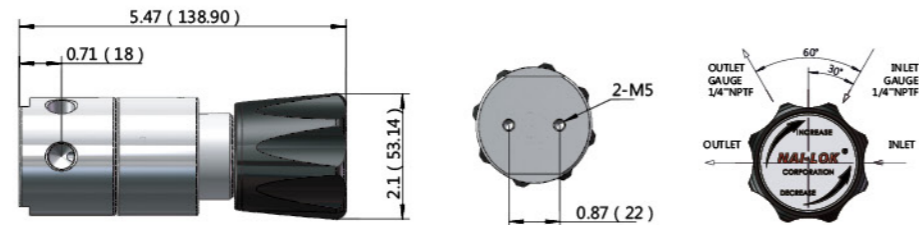

Dimension drawings shown are for reference only.

**Ordering Information**

NR41	S	2	F	4	1	4	W
BASIC SERIES	BODY MATERIAL	OUTLET PRESSURE RANGES	INLET AND OUTLET PORT TYPE	INLET AND OUTLET PORT SIZE	MAXIMUM INLET PRESSURE	PORT TYPE	GAUGE
NR41	C - Chrome plated brass	1-0-1000psig 0-69bar	F - NPTF	4 - 1/4"	1 - 6000psig 414bar	4 - 4 Ports	0-Without
	S - 316 Stainless steel	2-0-1500psig 0-103bar 3-0-3000psig 0-207bar					W-With

**NR61 SERIES**  
**High Flow Regulator**



**Features**

- Accurately regulates pressure up to 200 psig (13.8 bar) for spring load.
- Five outlet pressure ranges
- High flow for pipeline application
- 4 ports flexible configuration
- Spring loaded handknob

**Technical Data**

Ports	1" NPT
Design Proof Pressure	150% maximum rated pressure
Body Material	316 Stainless steel
Bonnet Material	316 Stainless steel
Diaphragm	Ethylene Propylene or Nylon Reinforced, Gylon ® (PTFE)
Seat	Viton ®, Chemraz ®
Maximum Inlet Pressure	3000 psig (207 bar) / 500 psig (34.5 bar)
Outlet Pressure Range	0-25 psig (0-1.7 bar) / 0-50 psig (0-3.4 bar) / 0-100 psig (0-6.9 bar) / 0-150 psig (0-10.3 bar) / 0-200 psig (13.8 bar)
Operating Temperature	-4°F to 165°F (-20°C to 74°C)
Leakage	Bubble-tight
Flow Capacity	Cv=5.0
Standard Optional	Tube fitting

**Flow Data**

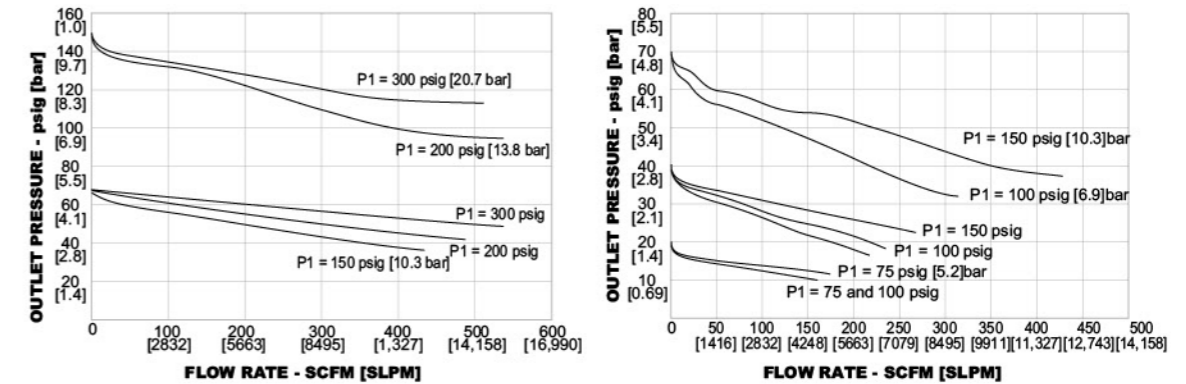

**Dimension (mm)**

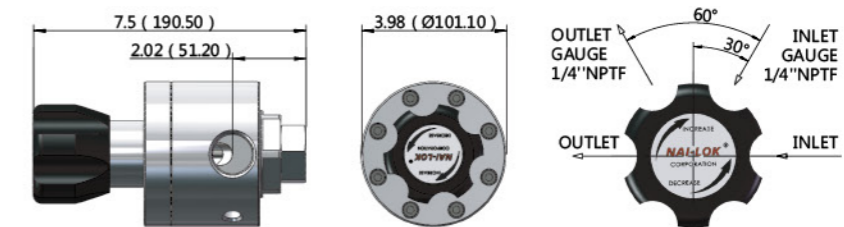

Dimension drawings shown are for reference only.

**Ordering Information**

NR61	S	2	F	16	1	3	W
BASIC SERIES	BODY MATERIAL	OUTLET PRESSURE RANGES	INLET AND OUTLET PORT TYPE	INLET AND OUTLET PORT SIZE	MAXIMUM INLET PRESSURE	PORT TYPE	GAUGE
NR61	S - 316 Stainless steel	0 - 0.25psig 0-1.7bar 1 - 0.50psig 0-3.4bar 2 - 0-100psig 0-6.9bar 3 - 0-150psig 0-10.3bar 4 - 0-200psig 0-13.8bar	F - NPTF	16 - 1"	1 - 3000psig 207bar 2 - 500psig 34.5bar	3 - 3 Ports 4 - 4 Ports	0-Without W-With

**NR71 SERIES**  
**Back Pressure Regulator**



**Features**

- Back pressure regulators work similarly to relief valves, but the emphasis is on steady state pressure control instead of on/off actuation
- Convuluted metal-to-metal sealed diaphragm
- Close pressure differential between crack and reseal
- Panel mounting nut option

**Technical Data**

Ports	1/4" NPT
Design Proof Pressure	150% maximum rated pressure
Body Material	316 Stainless steel
Seat Retainer	PEEK
Diaphragm	Hastelloy ® / 316 Stainless steel (standard)
O-ring	Viton ® , Kalrez ®
Controlled Pressure ranges	0-25 psig (1.7 bar) / 0- 50 psig (3.4 bar) / 0-100 psig ( 6.9 bar) / 0-250 psig (17.2 bar)
Operating Temperature	-15°F to 165°F (-26°C to 74°C)
Flow Capacity	Cv=0.3
Standard Optional	Tube fitting

**Flow Data**

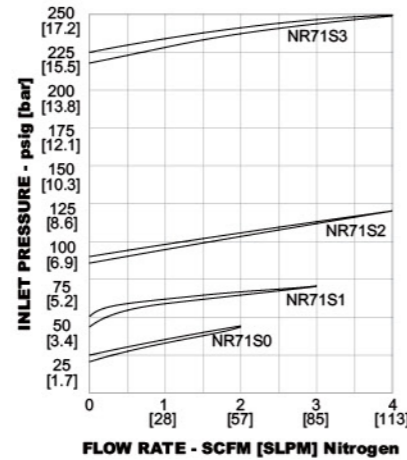

**Dimension (mm)**

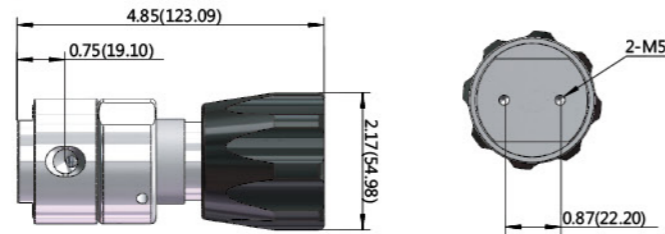

Dimension drawings shown are for reference only.

**Ordering Information**

NR71	S	2	2	4	2
BASIC SERIES	BODY MATERIAL	CONTROLLED PRESSURE RANGES	INLET AND OUTLET PORT TYPE	INLET AND OUTLET PORT SIZE	PORT TYPE
NR71	S - 316 Stainless steel	0 - 0.25psig 0-1.7bar 1 - 0.50psig 0-3.4bar 2 - 0.100psig 0-6.9bar 3 - 0.250psig 0-17.2bar	2 - NPTF	4 - 1/4"	2 - 2 Ports (no gauge ports)

**DHG SERIES**  
**High Flow Regulator**



**Features**

- Accurately regulates pressure up to 250 psig (17.2 bar) for spring load.
- High flow up to 1400scfm
- High flow for pipeline application
- 316 Stainless steel body for corrosive gases
- Spring loaded handknob

**Technical Data**

Ports	1 -1/2" NPT
Design Proof Pressure	150% maximum rated pressure
Body Material	316 Stainless steel
Bonnet Material	Stainless steel
Diaphragm	Gylon ®
Seat	Viton ® , Buna-N
Maximum Inlet Pressure	300 psig (20.7 bar)
Outlet Pressure Ranges	0-25 psig (0-1.7 bar) / 0-50 psig (0-3.4 bar) / 0-100 psig ( 0-6.9 bar) / 0-150psig (0-10.3 bar) / 0-250 psig (0-17.2 bar)
Operating Temperature	-10°F to 165°F (-23°C to 74°C)
Leakage	Bubble-tight
Flow Capacity	Cv=10
Standard Optional	Tube fitting

**Flow Data**

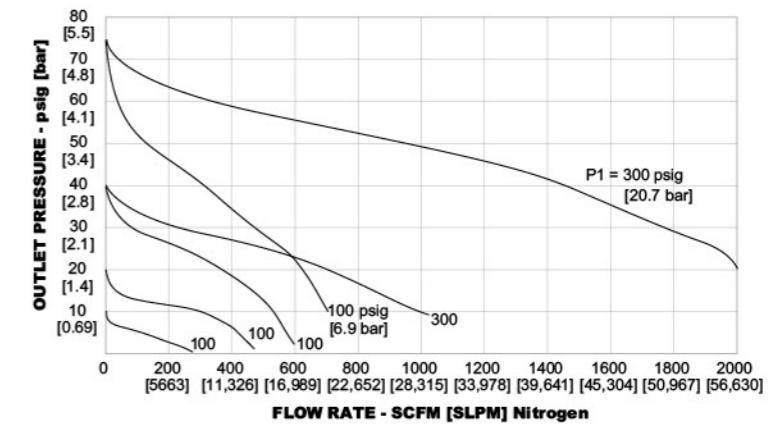

**Dimension (mm)**

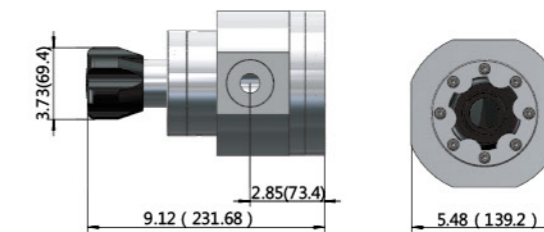

Dimension drawings shown are for reference only.

**Ordering Information**

DHG	S	2	F	24	1	2
BASIC SERIES	BODY MATERIAL	OUTLET PRESSURE	INLET AND OUTLET PORT TYPE	INLET AND OUTLET PORT SIZE	INLET PRESSURE	GAUGE PORT OPTIONS
DHG	S - 316 Stainless steel	0-0.25psig 0-1.7bar 1-0.50psig 0-3.4bar 2-0-100psig 0-6.9bar 3-0-150psig 0-10.3bar 4-0-250psig 0-17.2bar	F - NPTF	24 - 1-1/2"	1-300psig 21bar	2 - 2 Ports (no gauge ports)

**HRG90 SERIES**  
**High Flow Regulator**



**Features**

- Accurately regulate pressure up to 130 psig (8.9bar)
- High purity application
- Performs well at very low pressure differential

**Technical Data**

Maximum Rated Inlet Pressure	300 psig (21.2 bar)
Maximum Outlet Pressure	130 psig ( 8.9 bar )
Design Proof Pressure	150% maximum rated pressure
Body Material	316 Stainless steel
Operating Temperature	-20°F to 150°F (-29°C to 65°C)
Flow Capacity	Cv=8.0
Weight	66 lbs ( 30 kg )
Surface Grade	BA (standard) , Ra=10µin / Electropolishing, Ra=5µin

**Flow Data**

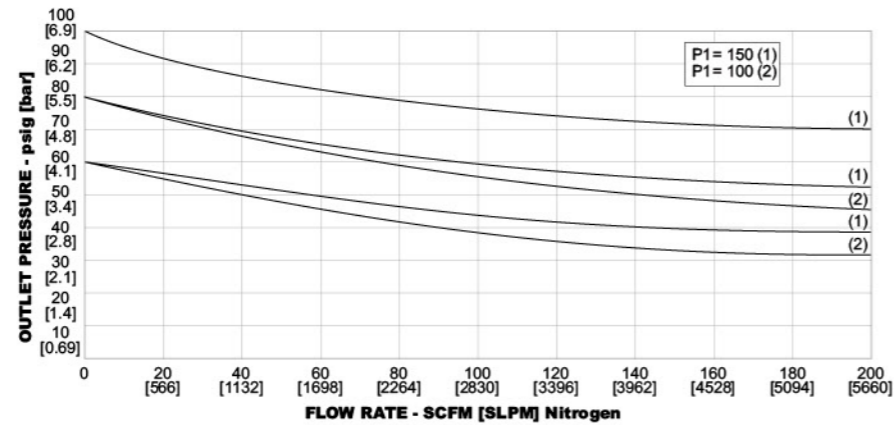

**Dimension (mm)**

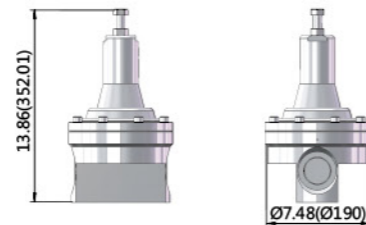

Dimension drawings shown are for reference only.

**Ordering Information**

BASIC SERIES	BODY MATERIAL	OUTLET PRESSURE	CONNECTION TYPE	CONNECTION SIZE	GAUGE
HRG90	S - 316 Stainless steel	0 - 0-130psig 0-8.9bar	F - NPTF TW - Tube Weld	32 - 2"	2- 2 Ports No gauge ports

**PRM SERIES**  
**Panel Regulator**



**Features**

- Single stage.
- For purity, inert, reactive, flammable and oxidizing gas and gas mixtures.
- Hastelloy-internals for corrosive gases
- Optional contact pressure gauges for gas supply failure monitoring
- Laboratory pressure control

**Technical Data**

Body Material	316 Stainless steel
Inlet Pressure	Max.300bar
Outlet Pressure	0-25 psig (1.7 bar) / 0- 50 psig (3.4 bar) / 0-100 psig ( 6.9 bar) / 0-250 psig (17.2 bar)/ 0-450 psig (31 bar)
Diaphragm (regulator)	Hastelloy ® / 316 Stainless steel (standard)
Operating Temperature	-40°F to 165°F (-40°C to 74°C)
Dimension (wxhxd)	320x160x153 mm
Weight	2.2KG
Inlet	1/4"FNPT
Outlet	1/4"FNPT
Optional	Relief valve, tube fitting

**Dimension (mm)**

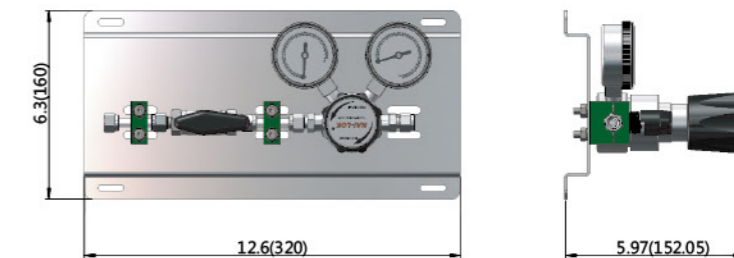

Dimension drawings shown are for reference only.

**Ordering Information**

PRM	S	1	0	4N	4N	R	GAS TYPE
BASIC SERIES	BODY MATERIAL	INLET PRESSURE	OUTLET PRESSURE RANGE	INLET CONNECTION	OUTLET CONNECTION	OPTION	GAS TYPE
PRM	S - 316 Stainless steel	1 - 4000 psig 276 bar	0-0-25psig 0-1.7bar 1-0-50psig 0-3.4bar 2-0-100psig 0-6.9bar 3-0-250psig 0-17.2bar 4-0-450psig 0-31bar	4F - 1/4"NPTF  4N- 1/4"OD	4F - 1/4"NPTF  4N- 1/4"OD	R- With relief valve	Please specify

**PMF SERIES**  
**Semi-automatic Changeover System**



**Features**

- Single stage.
- For purity, inert, reactive, flammable and oxidizing gas and gas mixtures.
- Hastelloy-internals for corrosive gases
- Uninterrupted gas supply with semi-automatic switch over
- Upgradable to max. 2x4 cylinders.

**Technical Data**

Body Material	316 Stainless steel
Inlet Pressure	Max. 300bar
Outlet Pressure	200 psig (13.8 bar)
Diaphragm (regulator)	Hastelloy ® / 316 Stainless steel (standard)
Operating Temperature	-40°F to 165°F (-40°C to 74°C)
Dimension (wxhxd)	400x154x153 mm
Weight	5.5KG
Inlet	1/4"FNPT
Outlet	1/4"FNPT
Optional	Relief valve, hose, tube fitting

**Dimension (mm)**

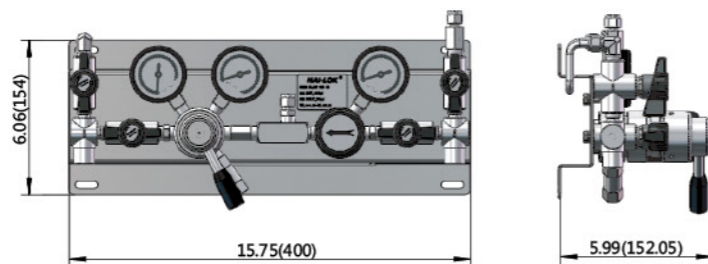

Dimension drawings shown are for reference only.

**Ordering Information**

PMF	S	40	20	4N	4N	W	
SERIES	BODY MATERIAL	INLET PRESSURE	OUTLET PRESSURE RANGE	INLET CONNECTION	OUTLET CONNECTION	PURGE VALVE	GAS TYPE
PMF	S - 316 Stainless steel	40-4000 psig 276 bar	20-200 psig 13.8 bar	4F - 1/4"NPTF 4N- 1/4"OD	4F - 1/4"NPTF 4N- 1/4"OD	0- Without W- With	Please specify

**PMF SERIES**  
**Semi-automatic Changeover System**

**Installation Example**

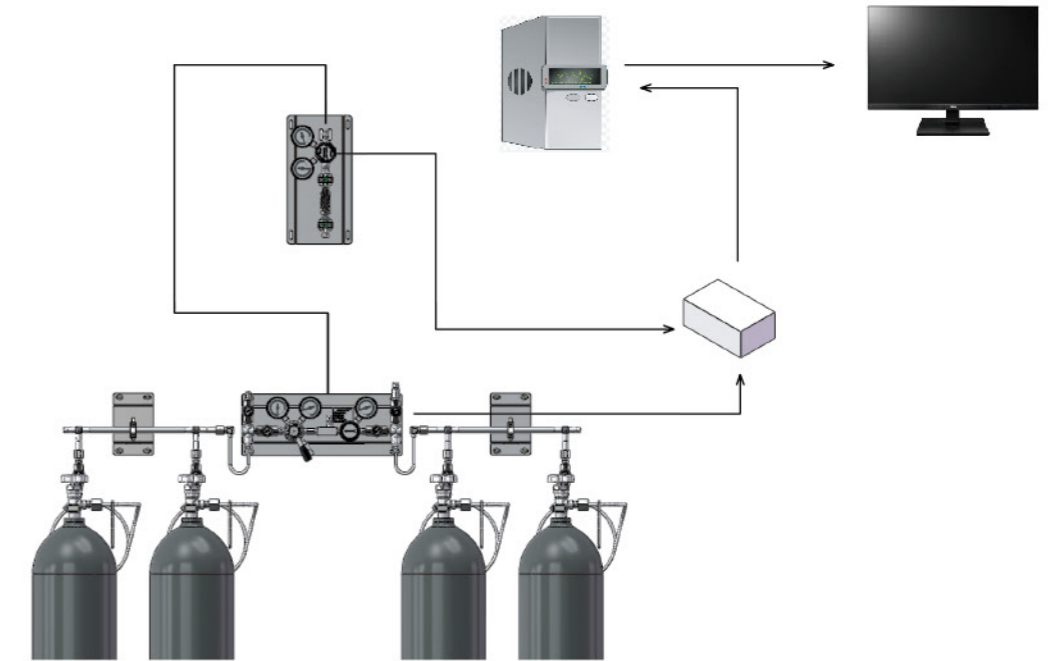

**Description**

PMF series is a continuous gas delivery system for high purity gas service, typically in the laboratory or process plant, that changes cylinder or bank priority from the primary source to a reserve supply without transmitting pressure fluctuations to the use line.

**How it works?**

Semi-automatic panels handle two cylinders (or bundles) at a time. When the pressure decreases in the active cylinder below a preset level which causes a semi-automatic switch to switch over to the full cylinder, this is achieved by two integrated pressure regulators. Factory set to slightly different delivery pressure levels, which are connected at their outlet ports. Moving the lever towards the full cylinder without interrupt the gas flow after the cylinders at the primary side are changed, the handle is turned thus changing the secondary side (delivering the gas) to the new primary side.

**Applications:**

Research purity or corrosive gas supply.  
Hydrogen and other flammable gases.  
Central gas supply system for laboratory research or process plants.

**Pigtail**



Material	316 Stainless steel
Max. Working Pressure	3500 psi / 241bar
Swivel Nut	M14x14.5 or NPT 1/4"M
Cylinder Connection	CGA / BSP / GB / JIS
Gas Type	Please specify

**PRD SERIES**  
**Panel Regulator**



**Features**

- Single stage.
- For purity, inert, reactive, flammable and oxidizing gas and gas mixtures.
- Hastelloy-internals for corrosive gases
- Process gas purging
- Laboratory pressure control

**Technical Data**

Body Material	316 Stainless steel
Inlet Pressure	Max.300 bar
Outlet Pressure	0-25 psig (1.7 bar) / 0- 50 psig (3.4 bar) / 0-100 psig ( 6.9 bar) / 0-250 psig (17.2 bar) / 0-450 psig (31 bar)
Diaphragm (regulator)	Hastelloy ® / 316 Stainless steel (standard)
Operating Temperature	-40°F to 165°F( -40°C to 74°C)
Dimension (wxhxd)	250x154x154 mm
Weight	3.0KG
Inlet	1/4"FNPT
Outlet	1/4"FNPT
Optional	Relief valve, tube fitting

**Dimension (mm)**

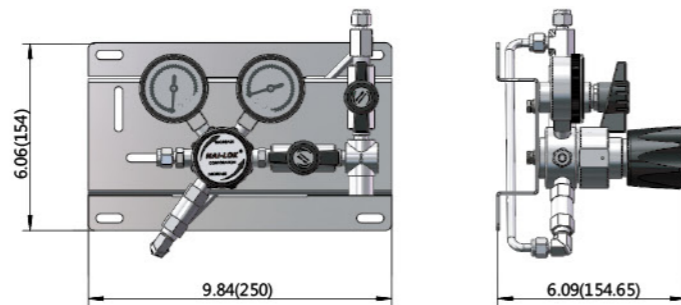

Dimension drawings shown are for reference only.

**Ordering Information**

PRD	S	1	0	4N	4N	R	
SERIES	BODY MATERIAL	INLET PRESSURE	OUTLET PRESSURE RANGES	INLET CONNECTION	OUTLET CONNECTION	OPTION	GAS TYPE
PRD	S - 316 Stainless steel	1 - 4000 psig 276 bar	0-0-25psig 0-1.7bar 1-0-50psig 0-3.4bar 2-0-100psig 0-6.9bar 3-0-250psig 0-17.2bar 4-0-450psig 0-31bar	4F - 1/4"NPTF 4N - 1/4"OD	4F - 1/4"NPTF 4N - 1/4"OD	R - With relief valve	Please specify

**DV SERIES**  
**Diaphragm Shut-off Valve**



**Features**

- For corrosive, inert, reactive, flammable and oxidizing gases and gas mixtures up to grade 6.0
- Quick operation through 90° shut-off function
- Clearly visible open/closed position

**Technical Data**

Ports	1/4" NPT
Body Material	316 Stainless steel / Nickel plated brass
Diaphragm	Elgiloy
Body Seal	PCTFE
Working Pressure	3000 psig (207 bar)
Operating Temperature	-13°F to 140°F (-25°C to 60°C)
Inlet / Outlet Filter	100 µm mesh
Optional	Panel mounting

**Dimension (mm)**

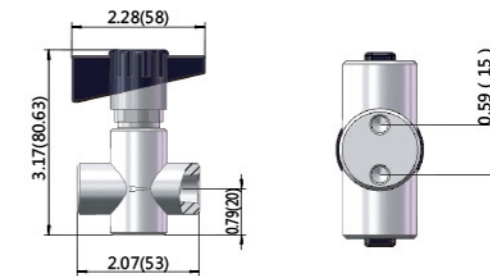

Dimension drawings shown are for reference only.

**Ordering Information**

DV	S	F	4	N <sub>2</sub>
BASIC SERIES	BODY MATERIAL	END CONNECTION	SIZE	GAS TYPE
DV	S - 316 Stainless steel N - Nickel plated brass	F - Female NPT N - NAI-LOK	4 - 1/4"	Please specify type of gas

**NPG SERIES**  
Pressure Gauge



**Features**

- Compact body, for installation in small space
- 100% factory tested, oil-free.
- Body material: 316 stainless steel
- Different pressure ranges are available.

**Technical Data**

Body Material	316 Stainless steel
Connection	1/4" NPT male
Dual Scale	Psig / Bar
Dial Face Size	2"



**Dimension (mm)**

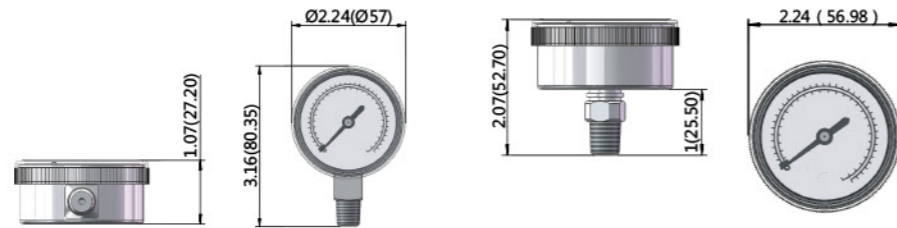

Dimension drawings shown are for reference only.

**Ordering Information**

NPG-B		S	M	4	A
BASIC SERIES		MATERIAL	CONNECTION	CONNECTION SIZE	PRESSURE RANGES
NPG	NPG-B (bottom connection) NPG-K (back connection)	S - 316 Stainless steel	M-Male NPT	4-1/4 in.	A-0-30psi / 2.1bar B-0-60psi / 4.2bar C-0-100psi / 6.9bar D-0-160psi / 11bar E-0-200psi / 13.8bar F-0-300psi / 20.6bar G-0-600psi / 41.3bar H-0-1000psi / 69bar I-0-1500psi / 103bar J-0-2000psi / 138bar K-0-2500psi / 173bar L-0-4000psi / 276bar M-0-6000psi / 414bar

**BG SERIES**  
Ball Valve



**Features**

- Pressure rating up to 3000psig(207bar)
- Working temperature from -50°F to 150°F(10°C to 65°C)
- Panel mountable as standard
- Size: NAI-LOK 1/4 to 1/2 in.
- Every valve is 100% factory tested with Nitrogen @1000psig(69bar)

**Technical Data**

Body Material	316 Stainless steel
Handle	Black Nylon
Mounting Nut	316 Stainless steel
Seat	PTFE
Packing	PTFE
Max Working Pressure	3000 psig (207 bar)
Working Temperature	-50°F to 150°F ( 10°C to 65°C ) For low working temperature, please contact factory
Size	1/4"-1/2"
End Connection	NPT female / NAI-LOK tube fitting

**Dimension (mm)**

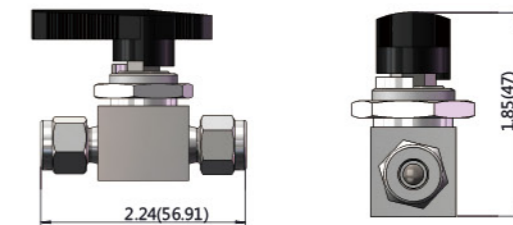

Dimension drawings shown are for reference only.

**Ordering Information**

BG	S	F	4	2
BASIC SERIES	MATERIAL	END CONNECTIONS	SIZE	DESIGN
BG	S - 316 Stainless steel	N - NAI - LOK F - Female NPT	4 - 1/4 in. 6 - 3/8 in. 8 - 1/2 in.	2 - 2 - way straight (standard) A - 2 - way angle 3 - 3 - way

**BR SERIES**  
**Ball Valve**

**Features**

- Maximum working pressure: 1000psig(68.9bar)
- Working Temperature: -20°F to 450°F(-28°C to 232°C)
- Compact and economical design
- Bi-directional flow
- Low operating torque
- Any reasonable connections available
- Options for handle color
- Leak-tight performance testing for every valve at the maximum working pressure with nitrogen



**Technical Data**

Body Material	316 Stainless steel
Handle	Black Nylon / Butterfly / Lever
Mounting Nut	316 Stainless steel
Seat	PTFE
Packing	PTFE
Max Working Pressure	1000 psig (69 bar)
Working Temperature	-20°F to 450°F (-28°C to 232°C)
Size	1/4"-1"
End Connection	Female / male / NAI-LOK tube fitting

**Dimension (mm)**

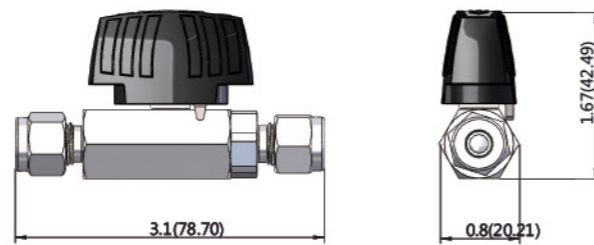

Dimension drawings shown are for reference only.

**Ordering Information**

BR	S	N	4	N
BASIC SERIES	MATERIAL	END CONNECTIONS	SIZE	HANDLE
BR	S - 316 Stainless steel	M - Male NPT N - NAI-LOK F - Female NPT	4 - 1/4 in. 6 - 3/8 in. 8 - 1/2 in. 12 - 3/4 in. 16 - 1 in.	N - Black Nylon L - Level B - Butterfly

\*Other end connection sizes please contact factory

**BV SERIES**  
**Ball Valve**

**Features**

- Pressure rating up to 6000 psig (414bar)
- Working temperature from -65°F to 450°F (-54°C to 232°C)
- Panel mountable as standard
- Every valve is 100% factory tested with Nitrogen @ 1000 psig (69 bar)
- Variety of end connections include reliable NAI-LOK tube fitting, Male / Female NPT & ISO / BSP thread.



**Technical Data**

Body Material	316 Stainless steel
Handle	Black Nylon
Mounting Nut	316 Stainless steel
Seat	PTFE
Packing	PTFE
Max Working Pressure	6000 psig (414 bar)
Working Temperature	-20°F to 450°F (-28°C to 232°C)
Size	1/4"-1/2"
End Connection	Female / male / NAI-LOK tube fitting

**Dimension (mm)**

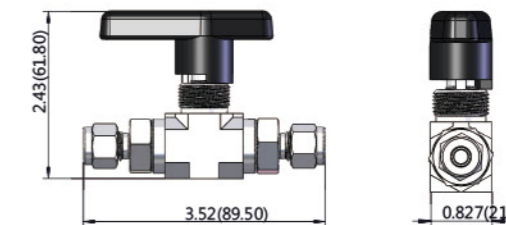

Dimension drawings shown are for reference only.

**Ordering Information**

BV	S	N	4	2
BASIC SERIES	MATERIAL	END CONNECTIONS	SIZE	DESIGN
BV	S - 316 Stainless steel	M - Male NPT N - NAI-LOK F - Female NPT	4 - 1/4 in. 6 - 3/8 in. 8 - 1/2 in.	2-2-way straight 3-3-way

\*Other end connection sizes please contact factory

**NG SERIES**  
**Needle Valve**



**Features**

- Maximum working pressure: 6000 psig (414 bar)
- Working temperature  
PTFE: -65°F to 450°F (-54°C to 232°C)  
PEEK: -65°F to 600°F (-54°C to 315°C)
- Compact design
- Leak-tight performance testing for every valve with nitrogen at the maximum working pressure

**Technical Data**

Body Material	316 Stainless steel
Handle	Black Knob, Anodized aluminum, Stainless steel
Panel Nut	316 Stainless steel
Maximum Working Pressure	6000 psig (414 bar)
Working Temperature	PTFE: -65°F to 450°F (-54°C to 232°C) PEEK: -65°F to 600°F (-54°C to 315°C)
Stem	316 Stainless steel
Packing	PTFE or PEEK
Size	1/4" to 1/2"
End Connection	NAI-LOK tube fitting or NPT thread

**Dimension (mm)**

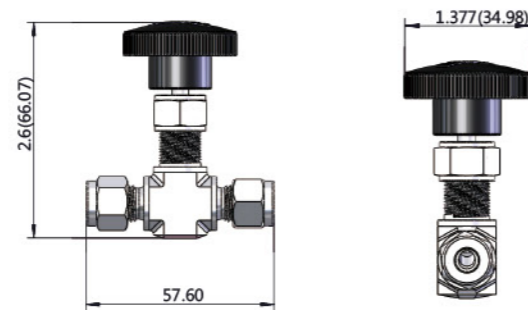

Dimension drawings shown are for reference only.

**Ordering Information**

NG	S	N	N	4
BASIC SERIES	MATERIAL	INLET CONNECTION	OUTLET CONNECTION	SIZE
NG	S - 316 Stainless steel	M-Male NPT	M-Male NPT	4-1/4 in.
		N-NAI-LOK	N-NAI-LOK	6-3/8 in.
		F-Female NPT	F-Female NPT	8-1/2 in.

\*Other end connection sizes please contact factory

**RV SERIES**  
**Relief Valve**



**Features**

- Compact body, for installation in small space
- Cracking pressure, adjustable externally
- Lock wire capability, to maintain pressure relief setting
- Operating temperature range: -10°F to 400°F (-23°C to 204°C)
- Orifice size: 4.8 mm (0.19in)
- Cracking pressure: is affected by the outlet pressure

**Technical Data**

Body Material	316 Stainless steel
Seal	Viton
Spring	SS316
Cracking Pressure Range	RV1: 15-225 psig / 1-15.5 bar to atmosphere RV2: 225-1500 psig / 16-104 bar to atmosphere
Max. working Pressure	RV1: 300 psig / 21 bar RV2: 6000 psig / 414 bar
Spring Types	Blue: 15-225 psig / 1-15.5 bar Yellow: 225-750 psig / 15.5-51.5 bar Purple: 750-1500 psig / 51.5-104 bar

**Dimension (mm)**

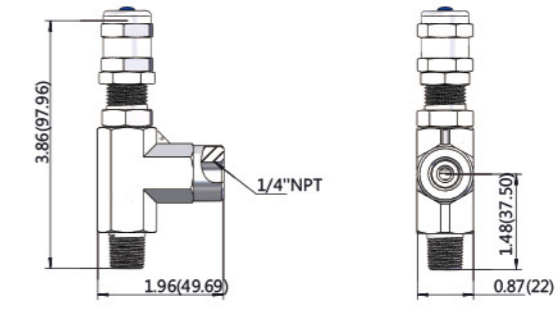

Dimension drawings shown are for reference only.

**Ordering Information**

RV1	S	M	F	4	L
BASIC SERIES	MATERIAL	INLET CONNECTION	OUTLET CONNECTION	SIZE	CRACKING PRESSURE
1-RV1	S - 316 Stainless steel	M-Male NPT	F-Female NPT	4-1/4 in.	L-15-225psig
2-RV2		N-NAI-LOK	N-NAI-LOK	6-3/8 in.	A-225-750psig
				8-1/2 in.	B-750-1500psig

\*Other end connection sizes please contact factory

**RVS SERIES**  
**Relief Valve**

**Features**

- For low pressure service.
- Direct acting, spring loaded.
- It will open when system pressure reaches the set level.
- 100% factory tested, for proper set and resealing performance.



**Technical Data**

Body Material	316 Stainless steel
Cracking Pressure	217 psig (15 bar) / 870 psig (60 bar)
Inlet Port	1/4"NPT Male
Outlet Port	1/4"NPT Female
Seal	Viton (standard)

**Dimension (mm)**

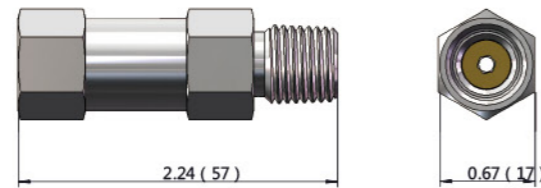

Dimension drawings shown are for reference only.

**Ordering Information**

RVS	S	M	F	4	15
BASIC SERIES	MATERIAL	INLET CONNECTION	OUTLET CONNECTION	SIZE	CRACKING PRESSURE
RVS	S - 316 Stainless steel	M-Male NPT	F-Female NPT	4-1/4 in.	15-0-217psig (0-15 bar) 60-217-870psig (15-60 bar)

**CV SERIES**  
**Check Valve**

**Features**

- Pressure rating up to 3000 psig (207 bar) @ 70°F (21°C)
- Temperature rating up to 375°F (191°C) with standard Viton O-ring
- 316SS body material as standard
- 100% factory tested
- Variety of end connections include NAI-LOK tube fitting, Male/Female NPT & ISO thread.



**Technical Data**

Body Material	316 Stainless steel
Working Pressure	3000 psig (207 bar )
Spring	302SS
O-Ring	Viton (standard)
Poppet	316 Stainless steel
End Connections	NAI-LOK tube fitting or NPT thread
Inlet / Outlet Size	1/4" to 1"
Nominal Cracking Pressure	1/3 psig

**Dimensions (mm)**

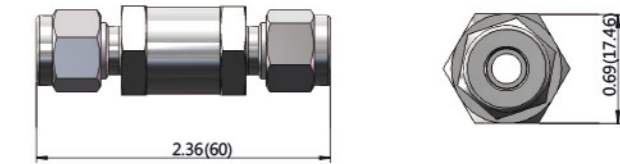

Dimension drawings shown are for reference only.

**Ordering Information**

CV	S	N	4	1
BASIC SERIES	MATERIAL	END CONNECTION	SIZE	CRACKING PRESSURE
CV	S - 316 Stainless steel	M-Male NPT N- NAI -LOK F- Female NPT	4 - 1/4 in. 6 - 3/8 in. 8 - 1/2 in. 12 - 3/4 in. 16 - 1 in.	1 - 1/3psi

\* Other end connection sizes please contact factory

**CVH SERIES**  
**Check Valve**



**Features**

- Pressure rating up to 6000 psig (414 bar) @ 70°F (21°C)
- Temperature rating up to 375°F ( 190°C ) with viton seal standard
- Suitable for gas and liquids
- Blow-out resistant and stop reversing flow design
- 316SS body material as standard
- 100% factory tested

**Technical Data**

Body	316 Stainless steel
Working Pressure	6000 psig (414 bar)
Spring	302SS
Poppet	316 Stainless steel
End Connection	NAI-LOK tube fitting or NPT thread
O-Ring & Back Up Rings	Viton (standard)
Nominal Cracking Pressure	1/3 psig
Poppet Stopper	316SS / A479
Spring	302SS

**Dimension (mm)**

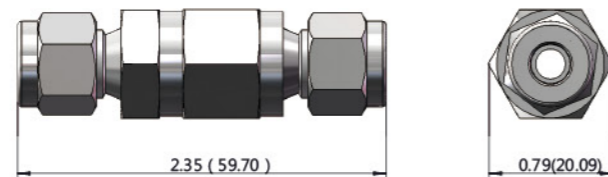

Dimension drawings shown are for reference only.

**Ordering Information**

CVH	S	N	4	1
BASIC SERIES	MATERIAL	END CONNECTION	SIZE	CRACKING PRESSURE
CVH	S - 316 Stainless steel	M- Male NPT N- NAI -LOK F- Female NPT	4-1/4 in. 6-3/8 in. 8-1/2 in. 12-3/4 in. 16-1 in.	1 - 1/3psi

\*Other end connection sizes please contact factory

**FI SERIES**  
**Micron Inline Filter**



**Features**

- Maximum operation pressure: 3000psig@70°F(20°C)
- In-line filters are for use where space is limited
- Particle trapping for clean fluid

**Technical Data**

Body	316 Stainless steel
Spring	302SS
Gasket	Silver-plated 316SS / A240
Filter Elements	316SS sintered
Max. Operating Pressure	3000 psig @ 70°F (21°C)
Operating Temperature	-20°F to 900°F (-28°C to 482°C)
End Connection	NAI-LOK tube fitting or NPT thread
Pore Size	25 µm

**Dimension (mm)**

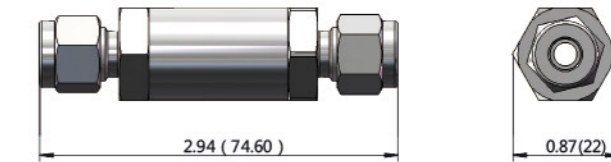

Dimension drawings shown are for reference only.

**Ordering Information**

FI	S	N	4	25
BASIC SERIES	MATERIAL	END CONNECTION	SIZE	PORE SIZE
FI	S - 316 Stainless steel	M- Male NPT N- NAI -LOK F- Female NPT	4 - 1/4 in. 6 - 3/8 in. 8 - 1/2 in.	25-25µm

\*Other end connection sizes please contact factory

**D100 SERIES**  
**Cylinder Valve**



**Features**

- High pressure cylinder valves
- Packed needle stem design
- For high purity gases
- Available in clockwise and anti-clockwise for outlet connection

**Technical Data**

Material	316 Stainless steel
Working Pressure	3000 psig (207 bar)
Temperature Range	-20°C to 70°C
Flow Coefficient	Cv = 0.3
Seat Orifice Size	3.3mm

**Dimension (mm)**

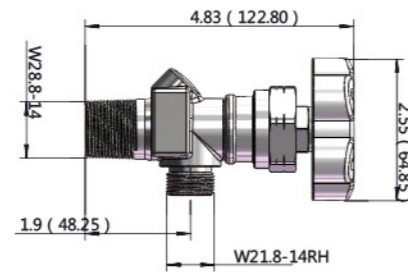

**Ordering Information**

D100	S	W	WR
BASIC SERIES	MATERIAL	INLET CONNECTION	OUTLET CONNECTION
D100	S - 316 Stainless steel	W-W28.8 DIN 477RH	WR-W21.8 DIN 477RH WL-W21.8 DIN 477LH

**QC SERIES**  
**Quick Connector**



**Features**

- Engineered to minimize spillage and air inclusion
- Available in a wide range of configurations, stem and body connectors
- Enable quick, easy connection with push-to-connect coupling designed for instrumentation

**Technical Data**

Material	316 Stainless steel
Max. Working Pressure	3000 psig (207 bar)
Working Temperature	-50°F to 150°F (10°C to 65°C)
Stem	316 Stainless steel
Poppet	316 Stainless steel
O-Ring	PTFE
End Connection	NAI-LOK tube fitting or NPT thread

**Dimension (mm)**

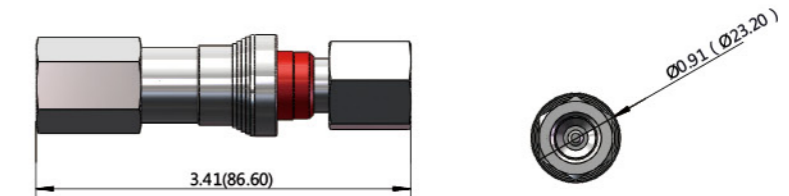

**Ordering Information**

QC	S	F	4
BASIC SERIES	MATERIAL	END CONNECTION	SIZE
QC	S - 316 Stainless steel	M- Male NPT N- NAI -LOK F- Female NPT	4 - 1/4 in. 6 - 3/8 in. 8 - 1/2 in.

\*Other end connection sizes please contact factory

**CGA**  
**Cylinder Connectors**

**Features**

- CGA Cylinder Connections
- Connect to a cylinder valve
- CGA fitting is a standardized system for the attachment of a compressed gas cylinders to the required regulator on transfer line
- 1/4" NPT male connection
- Maximum working pressure 3000psig(207bar) standard



Type	Thread	Material	Gases
CGA300	.825"-14NGO RH EXT	316L	C <sub>2</sub> H <sub>2</sub>
CGA320	.825"-14NGO RH EXT	316L	CO <sub>2</sub>
CGA326	.825"-14NGO RH EXT	316L	N <sub>2</sub> O
CGA346	.825"-14NGO RH EXT	316L	AIR
CGA350	.825"-14NGO LH EXT	316L	H <sub>2</sub> , CH <sub>4</sub> , CO
CGA510	.885"-14NGO LH INT	316L	C <sub>2</sub> H <sub>2</sub> , C <sub>3</sub> H <sub>8</sub> , C <sub>4</sub> H <sub>10</sub> , C <sub>2</sub> H <sub>4</sub> O
CGA540	.903"-14NGO RH EXT	316L	O <sub>2</sub>
CGA580	.965"-14NGO RH INT	316L	N <sub>2</sub> , Ar, He
CGA590	.965"-14NGO LH INT	316L	Air, He
CGA660	1.03"-14RH EXT	316L	CO <sub>2</sub> , CL <sub>2</sub>

**CGA Standards**

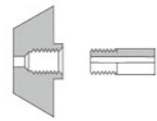

CGA 160 1/8"-27 NGT RH INT.

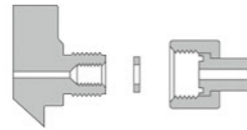

CGA 180 0.0625"-18 UNF 2A RH EXT. with Gasket

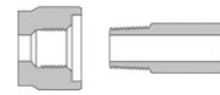

CGA 240 3/8"-18 NGT -RH INT.

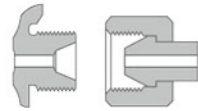

CGA 300 0.825"-14 NGO RH EX.

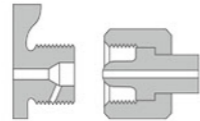

CGA 356 0.825"-14 RH EXT.

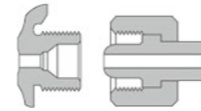

CGA 364 0.825"-14 NGO.

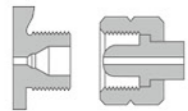

CGA 350 0.825"-14 LH RH EXT.

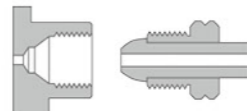

CGA 510 0.885"-14 LH INT.



CGA 540 0.903"-14 RH.

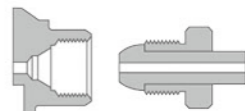

CGA 580 0.965"-14 RH INT.

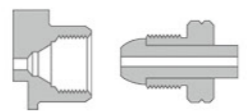

CGA 590 0.965"-14 NGO LH INT.

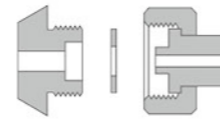

CGA 660 1.03"-14 with Gasket

\*For other type, please contact factory

**TSSM SERIES**  
**Supper Clean Tube**

**Features**

- Tubes according to ASTM A269/270, ASME BPE
- Bright annealing seamless tube
- For high purity pipeline and laboratory



**Technical Data**

Material	316 Stainless steel
Wall Thickness	0.028 inch -0.083 inch
Length	6000mm (optional: 4000mm) , (+/-10% possible)
Inside Surface Roughness	BA grade: Ry≤3.0 EP grade: Ry≤0.5
Size	1/8"- 1"

**Ordering Information**

TSSM	04	T035	L06	EP
BAIS SERIES	SIZE	THICKNESS	LENGTH	POLISH GRADE
TSSM	02-1/8 in. 04-1/4 in. 06-3/8 in. 08-1/2 in. 12-3/4 in. 16-1 in.	T028-0.028 in. T035-0.035 in. T049-0.049 in. T065-0.065 in. T083-0.083 in.	L04-4meter L06-6meter	BA - Bright Annealing EP - Electro Polishing

\*Other sizes please contact factory

**MFH SERIES**  
**Metal Flexible Hoses**



**Features**

- Vacuum and positive pressure applications
- Size: 1/4" to 1"
- Welded fitting-to-hose construction to ensure reliable seal
- Standard and custom length available.

**Technical Data**

Core Tube And Fitting Material	316 Stainless steel
Overbraid Material	316 Stainless steel / 304 Stainless steel
Working Pressure	3000 psig (207 bar)
Hose Size	1/4" to 1"
Working Temperature	-65°F to 400°F (-53°C to 204°C)
End Connection	NAI-LOK tube fitting or NPT thread

**Dimension (mm)**



Dimension drawings shown are for reference only.

**Ordering Information**

MFH	S	F	4	S	1
BASIC SERIES	END CONNECTION MATERIAL	END CONNECTION	SIZE	INNER MATERIAL	LENGTH
MFH	S - 316SS	M - Male NPT N - NAI-LOK F - Female NPT	4 - 1/4 in. 6 - 3/8 in. 8 - 1/2 in. 12 - 3/4 in. 16 - 1 in.	S - 316SS	1 - 1000mm 2 - 2000mm C - Customized length

**PBH SERIES**  
**PTFE-lined, Stainless Steel Braided Hoses**



**Features**

- Smooth virgin PTFE hose
- PTFE hose with permeation-resistant features
- Light weight construction
- Standard and custom length available.

**Technical Data**

Core Tube Material	Smooth virgin PTFE
Overbraid Material	316 Stainless steel / 304 Stainless steel
Working Pressure	1000 psig (69 bar)
Hose Size	1/4" to 1"
Working Temperature	-65°F to 400°F (-53°C to 204°C)
End Connection	NAI-LOK tube fitting or NPT thread

**Dimension (mm)**

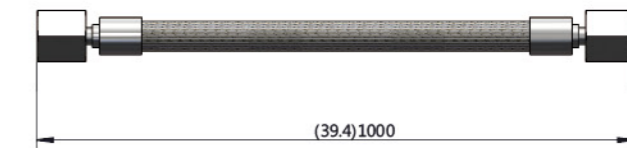

Dimension drawings shown are for reference only.

**Ordering Information**

PBH	S	F	4	P	1
BASIC SERIES	END CONNECTION MATERIAL	END CONNECTION	SIZE	INNER MATERIAL	LENGTH
PBH	S - 316SS	M - Male NPT N - NAI-LOK F - Female NPT	4 - 1/4 in. 6 - 3/8 in. 8 - 1/2 in. 12 - 3/4 in. 16 - 1 in.	P - PTFE	1 - 1000mm 2 - 2000mm C - Customized length

**HPH SERIES**  
**High Pressure Metal Hoses**

**Features**

- Vacuum and positive pressure applications
- Size: 1/4" to 1/2"
- Standard and custom length available.



**Technical Data**

Core Tube And Fitting Material	316 Stainless steel
Overbraid Material	316 Stainless steel / 304 Stainless steel
Working Pressure	4000 psig (276 bar)
Hose Size	1/4" to 1/2"
Working Temperature	-65°F to 400°F (-53°C to 204°C)

**Dimension (mm)**

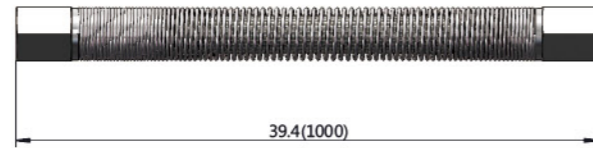

Dimension drawings shown are for reference only.

**Ordering Information**

HPH	S	F	4	S	1
BASIC SERIES	END CONNECTION MATERIAL	END CONNECTION	HOSE SIZE	INNER MATERIAL	LENGTH
HPH	S - 316SS	M - Male NPT N - NAI-LOK F - Female NPT	4- 1/4 in. 6 -3/8 in. 8- 1/2 in.	S - 316SS	1 - 1000mm 2 - 2000mm C - Customized length

**NU SERIES**  
**Union**

**Dimension**

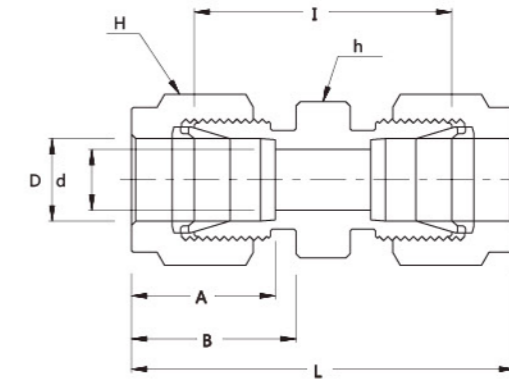

**Connects Fractional Tubes**

Part No.	Tube O.D D (inch)	d (Min)	Width Across Flat		A	B	I	L
			h (inch)	H (inch)				
NU-2	1/8	2.28	7/16	7/16	12.7	15.24	22.35	35.56
NU-4	1/4	4.82	1/2	9/16	15.24	17.78	26.16	40.89
NU-6	3/8	7.11	5/8	11/16	16.76	19.3	30.22	44.95
NU-8	1/2	10.41	13/16	7/8	22.86	21.84	30.98	51.3
NU-12	3/4	15.74	1-1/16	1-1/8	24.38	21.84	33.27	53.59
NU-16	1	22.35	1-3/8	1-1/2	31.24	26.41	40.38	64.77
NU-20	1-1/4	27.69	1-3/4	1-7/8	41.15	38.86	48.00	92.20
NU-24	1-1/2	34.04	2-1/8	2-1/4	50.04	45.21	53.59	107.95
NU-32	2	45.97	2-3/4	3	67.56	62.74	74.68	149.35

**Connects Metric Tubes**

Part No.	Tube O.D D (inch)	d (Min)	Width Across Flat		A	B	I	L
			h (inch)	H (inch)				
NU-8M	8	6.4	15	16	16.2	18.6	28.2	43.2
NU-10M	10	7.9	18	19	17.2	19.5	31	46.2
NU-12M	12	9.5	22	22	22.8	22	31	51.2
NU-16M	16	12.7	24	25	24.4	22	31.8	52
NU-20M	20	15.9	30	32	26	22	34.8	55
NU-25M	25	21.8	35	38	31.3	26.5	40.4	65

**NRU SERIES**  
Reducing Union

**Dimension**

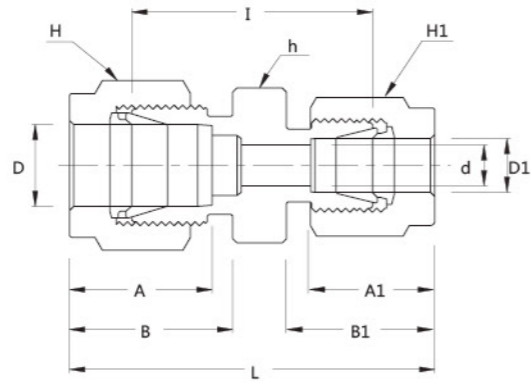
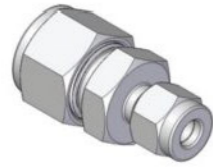

**Connects Fractional Tubes**

Part No.	Tube O.D.		d (Min)	Width Across Flat			A	A1	B	B1	I	L
	D (inch)	D1 (inch)		h (inch)	H (inch)	H1 (inch)						
NRU 4-2	1/4	1/8	2.28	1/2	9/16	7/16	15.24	12.7	17.78	15.24	24.63	38.6
NRU 6-2	3/8	1/8	2.28	5/8	11/16	7/16	16.76	12.7	19.3	15.24	26.92	40.89
NRU 6-4	3/8	1/4	4.82	5/8	11/16	9/16	16.76	15.24	19.3	17.78	28.44	43.18
NRU 8-2	1/2	1/8	2.28	13/16	7/8	7/16	22.86	12.7	21.84	15.24	28.44	45.21
NRU 8-4	1/2	1/4	4.82	13/16	7/8	9/16	22.86	15.24	21.84	17.78	29.46	46.99
NRU 8-6	1/2	3/8	7.11	13/16	7/8	11/16	22.86	16.76	21.84	19.3	30.98	48.51
NRU 12-4	3/4	1/4	4.82	1-1/16	1-1/8	9/16	24.38	15.24	21.84	17.78	31.75	49.27
NRU 12-6	3/4	3/8	7.11	1-1/16	1-1/8	11/16	24.38	16.76	21.84	19.3	33.27	50.8
NRU 12-8	3/4	1/2	10.41	1-1/16	1-1/8	7/8	24.38	22.86	21.84	21.84	33.27	53.59
NRU 16-8	1	1/2	10.41	1-3/8	1-1/2	7/8	31.24	22.86	26.41	21.84	39.5	63.24
NRU 16-12	1	3/4	15.74	1-3/8	1-1/2	1-1/8	31.24	24.38	26.41	21.84	39	62.73

**Connects Metric Tubes**

Part No.	Tube O.D.		d (Min)	Width Across Flat			A	A1	B	B1	I	L
	D (inch)	D1 (inch)		h (inch)	H (inch)	H1 (inch)						
NRU 8M-6M	8	6	4.8	15	16	14	16.2	15.3	18.6	17.7	27.4	42.3
NRU 12M-6M	12	6	4.8	22	22	14	22.8	15.3	22	17.7	29.5	47
NRU 12M-8M	12	8	6.4	22	22	16	22.8	16.2	22	18.6	30.2	47.8
NRU 16M-12M	16	12	9.5	24	25	22	24.4	22.8	22	22	31.8	52

**Connects Metric Tubes To Fractional Tubes**

Part No.	Tube O.D.		d (Min)	Width Across Flat			A	A1	B	B1	I	L
	D (inch)	D1 (inch)		h (inch)	H (inch)	H1 (inch)						
NRU 4M-4	4	1/4	2.4	14	12	14.3	13.7	15.3	16.1	17.7	25.4	39.4
NRU 6M-2	6	1/8	2.4	14	14	11.1	15.3	12.8	17.7	15.2	24.6	38.5
NRU 6M-4	6	1/4	4.8	14	14	14.3	15.3	15.3	17.7	17.7	26.2	41
NRU 8M-4	8	1/4	4.8	15	16	14.3	16.2	15.3	18.6	17.7	27.4	42.3
NRU 10M-2	10	1/8	2.4	18	19	11.1	17.2	12.8	19.5	15.2	27.7	41.8
NRU 10M-4	10	1/4	4.8	18	19	14.3	17.2	15.3	19.5	17.7	29.5	44.5
NRU 10M-6	10	3/8	7.1	18	19	17.5	17.2	16.9	19.5	19.2	31	45.9
NRU 12M-6	12	3/8	7.1	22	22	17.5	22.8	16.9	22	19.2	31	48.4
NRU 12M-8	12	1/2	9.5	22	22	22.2	22.8	22.8	22	22	31	51.2
NRU 20M-12	20	3/4	15.9	30	32	28.6	26	24.4	22	22	34.8	54.9

**NBHU SERIES**  
Bulkhead Union

**Dimension**

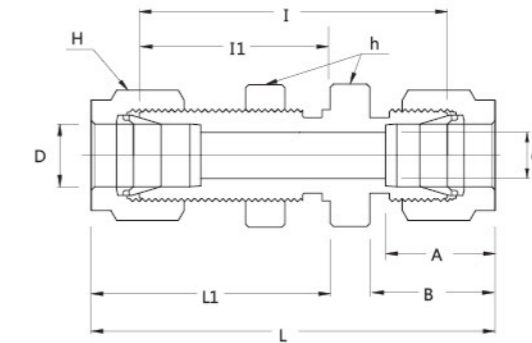

**Connects Fractional Tubes**

Part No.	Tube O.D.		Width Across Flat		A	B	I	I1	L	L1
	D (inch)	D1 (inch)	h (inch)	H (inch)						
NBHU-2	1/8	2.28	1/2	7/16	12.7	15.24	38.1	24.63	51.3	31.24
NBHU-4	1/4	4.82	5/8	9/16	15.24	17.78	42.92	26.16	57.65	33.52
NBHU-6	3/8	7.11	3/4	11/16	16.76	19.3	47.49	29.46	63.23	36.83
NBHU-8	1/2	10.41	15/16	7/8	22.86	21.84	50.8	31.75	71.12	41.91
NBHU-12	3/4	15.74	1-3/16	1-1/8	24.38	21.84	58.67	37.33	78.99	47.49
NBHU-16	1	22.35	1-5/8	1-1/2	31.24	26.41	71.37	45.21	95.75	57.4

**Connects Metric Tubes**

Part No.	Tube O.D.		Width Across Flat		A	B	I	I1	L	L1
	D (inch)	D1 (inch)	h (inch)	H (inch)						
NBHU-8M	8	6.4	18	17.5	16.2	18.6	46	28.6	61	36.1
NBHU-10M	10	7.9	22	22	17.2	19.5	48.5	29.46	63.7	37
NBHU-12M	12	9.5	24	23.8	22.8	22	50.8	31.8	71	41.9
NBHU-16M	16	12.7	27	27	24.4	22	52.3	32.5	72.5	42.6
NBHU-20M	20	15.9	35	35	26	22	64.3	42.9	84.5	53
NBHU-25M	25	21.8	41.3	41.3	31.3	26.5	71.4	45.21	95.9	57.5

**NMC SERIES**  
**Male Connector**

**Dimension**

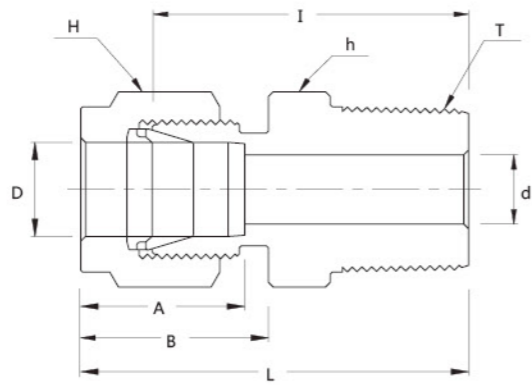

**Connects Fractional Tubes To Female NPT Thread**

Part No.	Tube O.D. D (inch)	T (NPT)	d Min	Width Across Flat		A	B	I	L
				h (inch)	H (inch)				
NMC 2-2N	1/8	1/8	2.28	7/16	7/16	12.7	15.24	23.87	30.48
NMC 2-4N	1/8	1/4	2.28	9/16	7/16	12.7	15.24	28.95	35.56
NMC 2-6N	1/8	3/8	2.28	11/16	7/16	12.7	15.24	29.21	35.81
NMC 2-8N	1/8	1/2	2.28	7/8	7/16	12.7	15.24	35.56	42.16
NMC 4-2N	1/4	1/8	4.82	1/2	9/16	15.24	17.78	25.4	32.76
NMC 4-4N	1/4	1/4	4.82	9/16	9/16	15.24	17.78	30.48	37.84
NMC 4-6N	1/4	3/8	4.82	11/16	9/16	15.24	17.78	30.98	38.35
NMC 4-8N	1/4	1/2	4.82	7/8	9/16	15.24	17.78	37.33	44.7
NMC 4-12N	1/4	3/4	4.82	1-1/16	9/16	15.24	17.78	38.86	46.22
NMC 6-2N	3/8	1/8	4.82	5/8	11/16	16.76	19.3	27.94	35.3
NMC 6-4N	3/8	1/4	7.11	5/8	11/16	16.76	19.3	32.51	39.87
NMC 6-6N	3/8	3/8	7.11	11/16	11/16	16.76	19.3	32.51	39.87
NMC 6-8N	3/8	1/2	7.11	7/8	11/16	16.76	19.3	38.86	46.22
NMC 6-12N	3/8	3/4	7.11	1-1/16	11/16	16.76	19.3	40.38	47.75
NMC 8-2N	1/2	1/8	4.82	13/16	7/8	22.86	21.84	28.7	38.86
NMC 8-4N	1/2	1/4	7.11	13/16	7/8	22.86	21.84	33.27	43.43
NMC 8-6N	1/2	3/8	9.65	13/16	7/8	22.86	21.84	33.27	43.43
NMC 8-8N	1/2	1/2	10.41	7/8	7/8	22.86	21.84	38.86	49.02
NMC 8-12N	1/2	3/4	10.41	1-1/16	7/8	22.86	21.84	40.38	50.54
NMC 8-16N	1/2	1	10.41	1-3/8	7/8	22.86	21.84	46.99	57.15
NMC 12-8N	3/4	1/2	11.93	1-1/16	1-1/8	24.38	21.84	40.38	50.54
NMC 12-12N	3/4	3/4	15.74	1-1/16	1-1/8	24.38	21.84	40.38	50.54
NMC 12-16N	3/4	1	15.74	1-3/8	1-1/8	24.38	21.84	46.99	57.15
NMC 16-8N	1	1/2	11.93	1-3/8	1-1/2	31.24	26.41	45.21	57.4
NMC 16-12N	1	3/4	15.74	1-3/8	1-1/2	31.24	26.41	45.21	57.4
NMC 16-16N	1	1	22.35	1-3/8	1-1/2	31.24	26.41	50.03	62.23

**NFC SERIES**  
**Female Connector**

**Dimension**

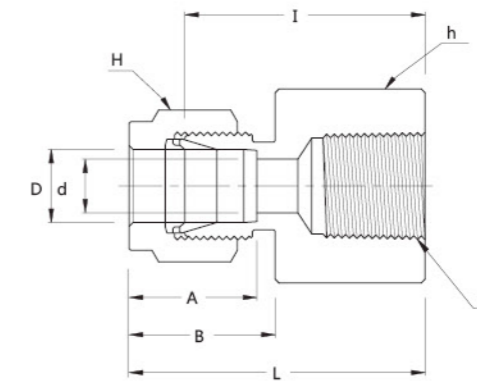
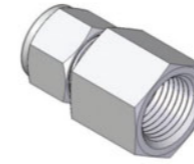

**Connects Fractional Tubes To Male NPT Thread**

Part No.	Tube O.D. D (inch)	T (NPT)	d (Min)	Width Across Flat		A	B	L	K
				h (inch)	H (inch)				
NFC 2-2N	1/8	1/8	2.28	9/16	7/16	12.7	15.24	22.09	28.7
NFC 2-4N	1/8	1/4	2.28	3/4	7/16	12.7	15.24	26.92	33.52
NFC 4-2N	1/4	1/8	4.82	9/16	9/16	15.24	17.78	23.87	31.24
NFC 4-4N	1/4	1/4	4.82	3/4	9/16	15.24	17.78	28.44	35.81
NFC 4-6N	1/4	3/8	4.82	7/8	9/16	15.24	17.78	30.22	37.59
NFC 4-8N	1/4	1/2	4.82	1-1/16	9/16	15.24	17.78	35.05	42.41
NFC 6-2N	3/8	1/8	7.11	5/8	11/16	16.76	19.3	25.4	32.76
NFC 6-4N	3/8	1/4	7.11	3/4	11/16	16.76	19.3	30.22	37.59
NFC 6-6N	3/8	3/8	7.11	7/8	11/16	16.76	19.3	31.75	39.11
NFC 6-8N	3/8	1/2	7.11	1-1/16	11/16	16.76	19.3	36.57	43.94
NFC 6-12N	3/8	3/4	7.11	1-5/16	11/16	16.76	19.3	40.38	47.75
NFC 8-4N	1/2	1/4	10.41	13/16	7/8	22.86	21.84	30.22	40.38
NFC 8-6N	1/2	3/8	10.41	7/8	7/8	22.86	21.84	31.75	41.91
NFC 8-8N	1/2	1/2	10.41	1-1/16	7/8	22.86	21.84	36.57	46.73
NFC 8-12N	1/2	3/4	10.41	1-5/16	7/8	22.86	21.84	38.1	48.26
NFC 12-8N	3/4	1/2	15.74	1-1/16	1-1/8	24.38	21.84	36.57	46.73
NFC 12-12N	3/4	3/4	15.74	1-5/16	1-1/8	24.38	21.84	38.1	48.26
NFC 16-12N	1	3/4	22.35	1-3/8	1-1/2	31.24	26.41	41.14	53.34
NFC 16-16N	1	1	22.35	1-5/8	1-1/2	31.24	26.41	50.03	62.23

**NUE SERIES**  
Union Elbow

**Dimension**

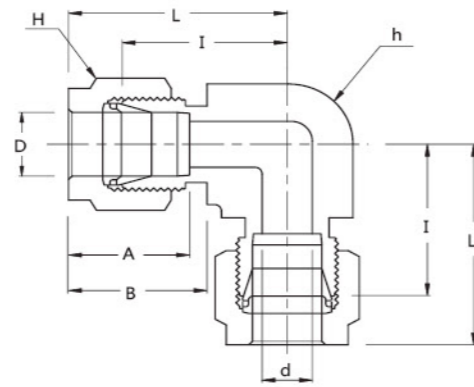
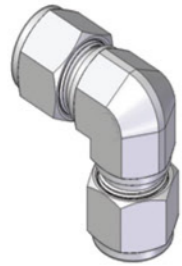

**Connects Fractional Tubes**

Part No.	Tube O.D. D (inch)	d (Min)	Width Across Flat		A	B	I	L
			h (inch)	H (inch)				
NUE-2	1/8	2.28	3/8	7/16	12.7	15.24	15.74	22.35
NUE-4	1/4	4.82	1/2	9/16	15.24	17.78	20.1	27.4
NUE-6	3/8	7.11	5/8	11/16	16.76	19.3	23.11	30.48
NUE-8	1/2	10.41	13/16	7/8	22.86	21.84	25.9	36.06
NUE-12	3/4	15.74	1-1/16	1-1/8	24.38	21.84	29.71	39.87
NUE-16	1	22.35	1-3/8	1-1/2	31.24	26.41	36.83	49.02
NUE-20	1-1/4	27.69	1-11/16	1-7/8	41.15	38.86	44.45	66.55
NUE-24	1-1/2	34.04	2	2-1/4	50.04	45.21	50.80	77.98
NUE-32	2	45.97	2-3/4	3	67.56	62.74	69.85	107.19

**Connects Metric Tubes**

Part No.	Tube O.D. D (inch)	d (Min)	Width Across Flat		A	B	I	L
			h (inch)	H (inch)				
NUE-6M	6	4.8	12.7	14	15.3	17.7	19.6	27
NUE-8M	8	6.4	15.9	16	16.2	18.6	22.4	29.9
NUE-10M	10	7.9	17.5	19	17.2	19.5	23.9	31.5
NUE-12M	12	9.5	20.6	22	22.8	22	25.9	36
NUE-16M	16	12.7	23.8	25	24.4	22	27.9	38
NUE-20M	20	15.9	34.9	32	26	22	34.5	44.6
NUE-25M	25	21.8	34.9	38	31.3	26.5	36.8	49.1

**NME SERIES**  
Male Elbow

**Dimension**

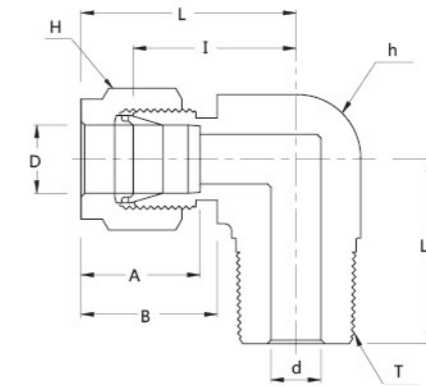
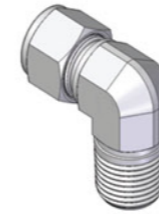

**Connects Fractional Tubes To Female NPT Thread**

Part No.	Tube O.D. D (inch)	T (NPT)	d (Min)	Width Across Flat		A	B	I	L	L1
				h (inch)	H (inch)					
NME 2-2N	1/8	1/8	2.28	1/2	7/16	12.7	15.24	18	24.3	18.8
NME 2-4N	1/8	1/4	2.28	1/2	7/16	12.7	15.24	18	24.3	23.36
NME 4-2N	1/4	1/8	4.82	1/2	9/16	15.24	17.78	19.55	26.92	18.79
NME 4-4N	1/4	1/4	4.82	1/2	9/16	15.24	17.78	19.55	26.92	23.36
NME 4-6N	1/4	3/8	4.82	5/8	9/16	15.24	17.78	22.35	29.71	26.16
NME 4-8N	1/4	1/2	4.82	13/16	9/16	15.24	17.78	24.38	31.75	33.02
NME 6-2N	3/8	1/8	4.82	5/8	11/16	16.76	19.3	23.11	30.48	20.82
NME 6-4N	3/8	1/4	7.11	5/8	11/16	16.76	19.3	23.11	30.48	25.4
NME 6-6N	3/8	3/8	7.11	5/8	11/16	16.76	19.3	23.87	31.24	26.16
NME 6-8N	3/8	1/2	7.11	13/16	11/16	16.76	19.3	25.9	33.27	33.02
NME 6-12N	3/8	3/4	7.11	1-1/16	11/16	16.76	19.3	29.71	37.08	36.83
NME 8-4N	1/2	1/4	7.11	13/16	7/8	22.86	21.84	25.9	36.06	28.19
NME 8-6N	1/2	3/8	9.65	13/16	7/8	22.86	21.84	25.9	36.06	28.19
NME 8-8N	1/2	1/2	10.41	13/16	7/8	22.86	21.84	25.9	36.06	33.02
NME 8-12N	1/2	3/4	10.41	1-1/16	7/8	22.86	21.84	29.71	39.87	36.83
NME 12-8N	3/4	1/2	11.93	1-1/16	1-1/8	24.38	21.84	29.71	39.87	36.83
NME 12-12N	3/4	3/4	15.74	1-1/16	1-1/8	24.38	21.84	29.71	39.87	36.83
NME 16-12N	1	3/4	15.74	1-3/8	1-1/2	31.24	26.41	36.83	49.02	41.65
NME 16-16N	1	1	22.35	1-3/8	1-1/2	31.24	26.41	36.83	49.02	46.48

**Connects Fractional Tubes To Female NPT Thread**

Part No.	Tube O.D. D (inch)	T (NPT)	d (Min)	Width Across Flat		A	B	I	L	L1
				h (inch)	H (inch)					
NME 4M-4N	4	1/4	2.4	12.7	12	13.7	16.1	18.8	25.4	23.4
NME 6M-2N	6	1/8	4.8	12.7	14	15.3	17.7	19.6	27	18.8
NME 6M-4N	6	1/4	4.8	12.7	14	15.3	17.7	19.6	27	23.4
NME 6M-6N	6	3/8	4.8	15.9	14	15.3	17.7	22.4	29.8	26.2
NME 6M-8N	6	1/2	4.8	20.6	14	15.3	17.7	24.4	31.8	33
NME 8M-2N	8	1/8	4.8	14.3	16	16.2	18.6	21.3	28.8	19.8
NME 8M-4N	8	1/4	6.4	14.3	16	16.2	18.6	21.3	28.8	24.4
NME 8M-6N	8	3/8	6.4	15.9	16	16.2	18.6	23.1	30.6	26.2
NME 8M-8N	8	1/2	6.4	20.6	16	16.2	18.6	25.1	32.6	33
NME 10M-8N	10	1/2	7.9	20.6	19	17.2	19.5	25.9	33.5	33
NME 12M-4N	12	1/4	7.1	20.6	22	22.8	22	25.9	36	28.2
NME 12M-6N	12	3/8	9.5	20.6	22	22.8	22	25.9	36	28.2
NME 12M-8N	12	1/2	9.5	20.6	22	22.8	22	25.9	36	33
NME 12M-12N	12	3/4	9.5	27	22	22.8	22	29.7	39.8	36.8
NME 16M-8N	16	1/2	11.9	23.8	25	24.4	22	27.9	38	35.1
NME 16M-12N	16	3/4	12.7	27	25	24.4	22	29.7	39.8	36.8

**NUT SERIES**  
Union Tee



**Dimension**

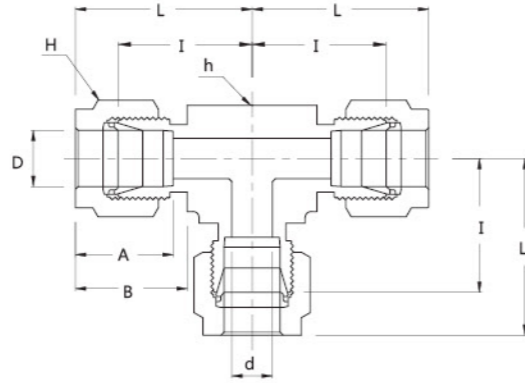
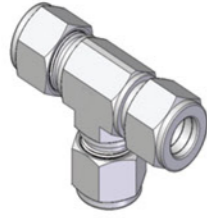

**Connects Fractional Tubes**

Part No.	Tube O.D. D (inch)	d (Min)	Width Across Flat		A	B	I	L
			h (inch)	H (inch)				
NUT-4	1/4	4.82	1/2	9/16	15.24	17.78	20.1	27.4
NUT-6	3/8	7.11	5/8	11/16	16.76	19.3	23.11	30.48
NUT-8	1/2	10.41	13/16	7/8	22.86	21.84	25.9	36.06
NUT-12	3/4	15.74	1-1/16	1-1/8	24.38	21.84	29.71	39.87
NUT-16	1	22.35	1-3/8	1-1/2	31.24	26.41	36.83	49.02
NUT-20	1-1/4	27.69	1-11/16	1-7/8	41.15	38.86	44.45	66.55
NUT-24	1-1/2	34.04	2	2-1/4	50.04	45.21	50.80	77.98
NUT-32	2	45.97	2-3/4	3	67.56	62.74	69.85	107.19

**Connects Metric Tubes**

Part No.	Tube O.D. D (inch)	d (Min)	Width Across Flat		A	B	I	L
			h (inch)	H (inch)				
NUT-8M	8	6.4	15.9	16	16.2	18.6	22.4	29.9
NUT-10M	10	7.9	17.5	19	17.2	19.5	23.9	31.5
NUT-12M	12	9.5	20.6	22	22.8	22	25.9	36
NUT-16M	16	12.7	25.4	25	24.4	22	28.7	38.8
NUT-20M	20	15.9	34.9	32	26	22	34.5	44.6
NUT-25M	25	21.8	34.9	38	31.3	26.5	36.8	49.1

**NFBT SERIES**  
Female Branch Tee



**Dimension**

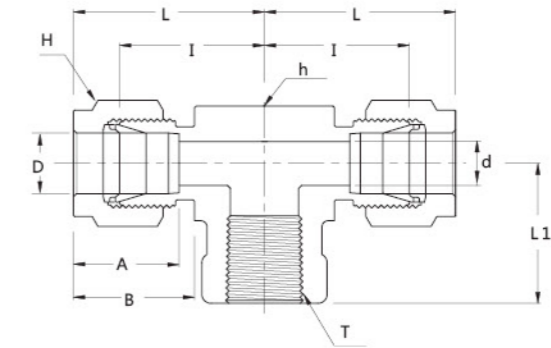
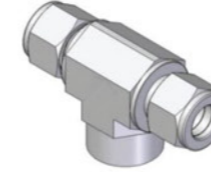

**Connects Fractional Tubes**

Part No.	Tube O.D. D (inch)	T (NPT)	d (Min)	Width Across Flat		A	B	I	L	L1
				h (inch)	H (inch)					
NFBT 4-2N	1/4	1/8	4.82	1/2	9/16	15.24	17.78	19.55	26.92	19.05
NFBT 4-4N	1/4	1/4	4.82	11/16	9/16	15.24	17.78	22.35	29.71	22.35
NFBT 6-4N	3/8	1/4	7.11	11/16	11/16	16.76	19.3	23.87	31.24	22.35
NFBT 6-6N	3/8	3/8	7.11	13/16	11/16	16.76	19.3	25.9	33.27	22.35
NFBT 6-8N	3/8	1/2	7.11	1	11/16	16.76	19.3	28.7	36.07	28.45
NFBT 8-4N	1/2	1/4	10.41	13/16	7/8	22.86	21.84	25.9	36.06	22.35
NFBT 8-6N	1/2	3/8	10.41	13/16	7/8	22.86	21.84	25.9	36.06	22.35
NFBT 8-8N	1/2	1/2	10.41	1	7/8	22.86	21.84	28.7	38.86	28.44
NFBT 12-12N	3/4	3/4	15.74	1-3/8	1-1/8	24.38	21.84	34.54	44.7	31.75
NFBT 16-12N	1	3/4	22.35	1-3/8	1-1/2	31.24	26.41	36.83	49.02	31.75
NFBT 16-16N	1	1	22.35	1-11/16	1-1/2	31.24	26.41	41.4	53.59	38.1

**Connects Metric Tubes To Male NPT Thread**

Part No.	Tube O.D. D (inch)	T (NPT)	d (Min)	Width Across Flat		A	B	I	L	L1
				h (inch)	H (inch)					
NFBT 6M-4N	6	1/4	4.8	17.46	14	15.3	17.7	22.4	29.8	22.4
NFBT 6M-6N	6	3/8	4.8	20.63	14	15.3	17.7	24.4	31.7	22.4
NFBT 6M-8N	6	1/2	4.8	25.4	14	15.3	17.7	27.2	34.5	28.4
NFBT 8M-2N	8	1/8	6.4	15.87	16	16.2	18.6	22.4	29.9	19
NFBT 8M-4N	8	1/4	6.4	17.46	16	16.2	18.6	23.1	30.6	22.4
NFBT 8M-6N	8	3/8	6.4	20.63	16	16.2	18.6	25.2	32.4	22.4
NFBT 8M-8N	8	1/2	6.4	25.4	16	16.2	18.6	28	35.2	28.4
NFBT 10M-4N	10	1/4	7.9	20.63	19	17.2	19.5	25.9	33.5	22.4
NFBT 10M-6N	10	3/8	7.9	20.63	19	17.2	19.5	25.9	33.3	22.4
NFBT 10M-8N	10	1/2	9.5	25.4	19	17.2	19.5	26.2	33.6	22.4
NFBT 12M-4N	12	1/4	9.5	20.63	22	22.8	22	25.9	36	22.4
NFBT 12M-6N	12	3/8	9.5	20.63	22	22.8	22	25.9	36	22.4
NFBT 12M-8N	12	1/2	9.5	25.4	22	22.8	22	29.7	40	28.4

**NR SERIES**  
Reducer



**Dimension**

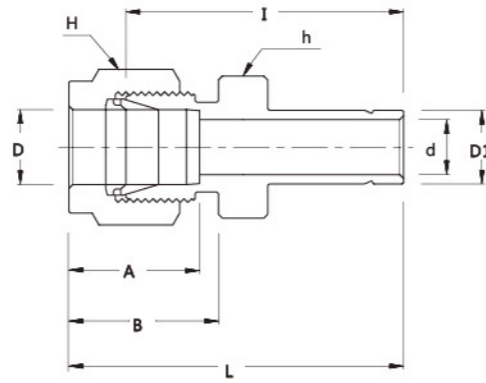

**Connects Fractional Tubes To Fractional NAI-LOK Port**

Part No.	Tube O.D.		d (Min)	Width Across Flat		A	B	I	L
	D (inch)	D1 (inch)		h (inch)	H (inch)				
NR2-2	1/8	1/8	2.03	7/16	7/16	12.7	15.24	26.92	33.52
NR2-4	1/8	1/8	2.28	7/16	7/16	12.7	15.24	29.46	36.06
NR2-6	1/8	3/8	2.28	7/16	7/16	12.7	15.24	30.98	37.59
NR2-8	1/8	1/2	2.28	9/16	7/16	12.7	15.24	37.59	44.19
NR4-2	1/4	1/8	2.03	1/2	9/16	15.24	17.78	29.46	36.83
NR4-4	1/4	1/4	4.82	1/2	9/16	15.24	17.78	31.75	39.11
NR4-6	1/4	3/8	4.82	1/2	9/16	15.24	17.78	33.27	40.64
NR4-8	1/4	1/2	4.82	9/16	9/16	15.24	17.78	38.86	46.22
NR4-12	1/4	3/4	4.82	13/16	9/16	15.24	17.78	41.4	47.75
NR6-4	3/8	1/4	4.82	5/8	11/16	16.76	19.3	34.03	41.4
NR6-6	3/8	3/8	7.11	5/8	11/16	16.76	19.3	35.81	43.18
NR6-8	3/8	1/2	7.11	5/8	11/16	16.76	19.3	41.14	48.51
NR6-12	3/8	3/4	7.11	13/16	11/16	16.76	19.3	42.92	50.29
NR8-4	1/2	1/4	4.82	13/16	7/8	22.86	21.84	34.79	44.95
NR8-6	1/2	3/8	7.11	13/16	7/8	22.86	21.84	36.57	46.73
NR8-8	1/2	1/2	9.9	13/16	7/8	22.86	21.84	42.16	52.32
NR8-12	1/2	3/4	10.41	13/16	7/8	22.86	21.84	43.68	53.84
NR8-16	1/2	1	10.41	1-1/16	7/8	22.86	21.84	50.03	60.19
NR12-8	3/4	1/2	9.9	1-1/16	1-1/8	24.38	21.84	44.45	54.61
NR12-16	3/4	1	15.74	1-1/16	1-1/8	24.38	21.84	52.32	62.48

**Connects Metric Tubes To Metric NAI-LOK Port**

Part No.	Tube O.D.		d (Min)	Width Across Flat		A	B	I	L
	D (inch)	D1 (inch)		h (inch)	H (inch)				
NR 6M-8M	6	8	4.8	14	14	15.3	17.7	32.5	39.9
NR 6M-10M	6	10	4.8	14	14	15.3	17.7	33.3	40.7
NR 6M-12M	6	12	4.8	14	14	15.3	17.7	38.9	46.3
NR 8M-6M	8	6	4.6	15	16	16.2	18.6	32.8	40.3
NR 8M-10M	8	10	6.4	15	16	16.2	18.6	34.5	42
NR 8M-12M	8	12	6.4	15	16	16.2	18.6	40.1	47.6
NR 10M-6M	10	6	4.6	18	19	17.2	19.5	34.8	42.4
NR 10M-8M	10	8	6.4	18	19	17.2	19.5	35.8	43.4
NR 10M-12M	10	12	7.9	18	19	17.2	19.5	42.2	49.8
NR 12M-6M	12	6	4.6	22	22	22.8	22	34.8	44.9
NR 12M-8M	12	8	6.4	22	22	22.8	22	35.8	45.9
NR 12M-10M	12	10	7.7	22	22	22.8	22	36.6	46.7
NR 12M-16M	12	16	9.5	22	22	22.8	22	43.7	53.8
NR 16M-12M	16	12	9.1	24	25	24.4	22	42.9	53
NR 20M-16M	20	16	12.7	30	32	26	22	47.8	57.9

**NP SERIES**  
Plug



**Fractional**

Part No.	Tube O.D. D (inch)	Width Across Flat H (inch)	Part No.	Tube O.D. D (inch)	Width Across Flat H (inch)
NP-2	1/8	7/16	NP-8	1/2	7/8
NP-4	1/4	9/16	NP-12	3/4	1-1/8
NP-6	3/8	11/16	NP-16	1	1-1/2

**Metric**

Part No.	Tube O.D. D (inch)	Width Across Flat H (mm)	Part No.	Tube O.D. D (inch)	Width Across Flat H (mm)
NP-4M	4	12	NP-12M	12	22
NP-6M	6	14	NP-16M	16	25
NP-8M	8	16	NP-20M	20	32
NP-10M	10	19	NP-25M	25	38

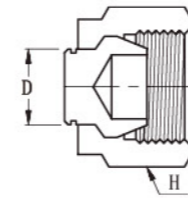

**NC SERIES**  
Cap

**Connects Caps End of Fractional Tubes**

Part No.	Tube O.D. D (inch)	Width Across Flat		A	B	I	L
		h (inch)	H (inch)				
NC-4	1/4	1/2	9/16	15.24	17.78	16.00	23.36
NC-6	3/8	5/8	11/16	16.76	19.30	18.28	25.65
NC-8	1/2	13/16	7/8	22.86	21.84	19.05	29.21
NC-12	3/4	1-1/16	1-1/8	24.38	21.84	21.33	31.49
NC-16	1	1-3/8	1-1/2	31.24	26.41	26.16	38.35

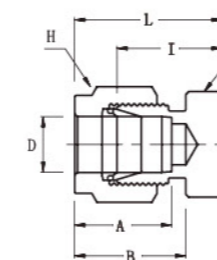

**Connects Metric Tubes**

Part No.	Tube O.D. D (inch)	Width Across Flat		A	B	I	L
		NC-4M	4				
NC-4M	4	12	12	13.7	16.1	14.7	21.3
NC-6M	6	14	14	15.3	17.7	15.7	23.1
NC-8M	8	15	16	16.2	18.6	17.0	24.5
NC-10M	10	18	19	17.2	19.5	19.0	26.6
NC-12M	12	22	22	22.8	22.0	19.0	29.1
NC-16M	16	24	25	24.4	22.0	19.8	29.9
NC-20M	20	30	32	26.0	22.0	23.9	34.0
NC-25M	25	35	38	31.3	26.5	26.2	38.5

**NN SERIES**

**Nut**

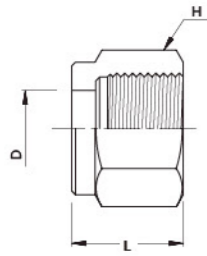
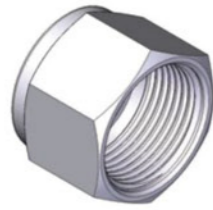

**Fractional**

Part No.	Tube O.D. (inch)	H (inch)	L
NN-2	1/8	7/16	11.93
NN-4	1/4	9/16	12.7
NN-6	3/8	11/16	14.22
NN-8	1/2	7/8	17.52
NN-12	3/4	1-1/8	17.52
NN-16	1	1-1/2	20.6

**Metric**

Part No.	Tube O.D. (inch)	H (inch)	L
NN-4M	4	12	11.9
NN-6M	6	14	12.7
NN-8M	8	16	13.5
NN-10M	10	19	15.1
NN-12M	12	22	17.4
NN-16M	16	25	17.4
NN-18M	18	30	17.4
NN-20M	20	32	17.4
NN-22M	22	32	17.4
NN-25M	25	38	20.6

**NFS SERIES**

**Ferrule Set**



**Fractional**

Part No.	Tube O.D. (inch)
NFS-2	1/8
NFS-4	1/4
NFS-6	3/8
NFS-8	1/2
NFS-12	3/4
NFS-16	1

**Metric**

Part No.	Tube O.D. (inch)	Part No.	Tube O.D. (inch)
NFS-4M	4	NFS-16M	16
NFS-6M	6	NFS-18M	18
NFS-8M	8	NFS-20M	20
NFS-10M	10	NFS-22M	22
NFS-12M	12	NFS-25M	25

**NHN SERIES**

**Hex Nipple**



Part No.	Pipe Size (inch)
NHN-4	1/4
NHN-8	1/2
NHN-12	3/4
NHN-16	1

**NMP SERIES**

**Male Plug**



Part No.	Pipe Size (inch)
NMP-4	1/4

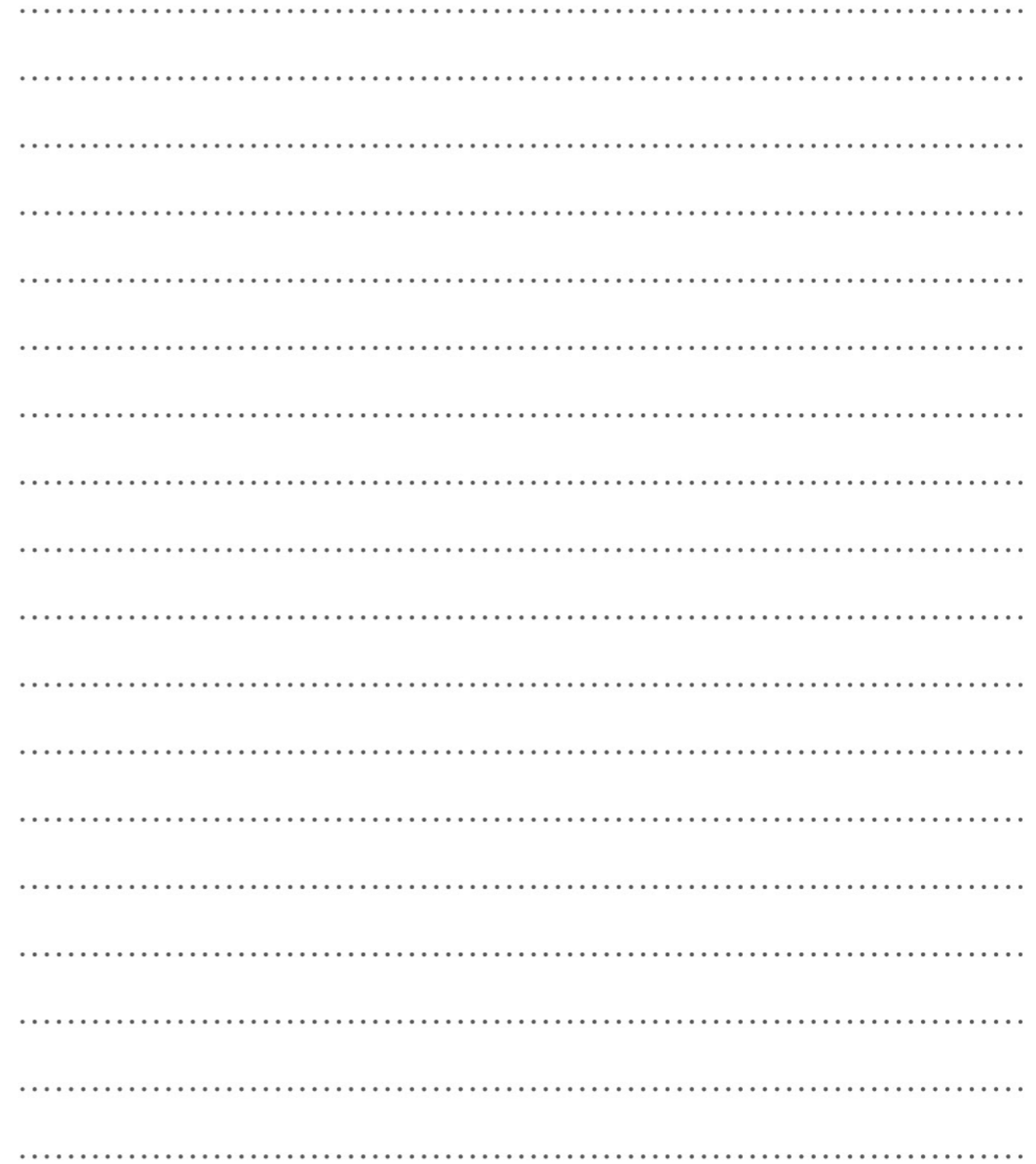

Thank you for choosing NAI-LOK.